

Manual

Division
Radiomonitoring and Radiolocation

MINIPOINT RECEIVER

R&S[®] EB200[®]

4052.2000.02



ROHDE & SCHWARZ

R&S® ist eingetragenes Warenzeichen der Fa. Rohde & Schwarz GmbH & Co. KG.
Eigennamen sind Warenzeichen der jeweiligen Eigentümer.

R&S® is a registered trademark of Rohde & Schwarz GmbH & Co. KG.
Proper names are trademarks of the respective owners.

Printed in the Federal
Republic of Germany

Rohde & Schwarz GmbH & Co. KG
Mühdorfstraße 15
D-81671 München
www.rohde-schwarz.com

Contents

1 Data sheet	PD757.3728
2 Preparation for Use	2.1
2.1 Installation	2.1
2.2 Wiring	2.2
2.3 Pin assignment of the connectors	2.3
2.4 Operation with Battery Pack EB200BP	2.3
2.5 Operation in a vehicle	2.4
2.6 Image of the Display in the Internet Browser	2.4
3 Operation	3.1
3.1 Description of the front panel	3.1
3.2 Overall view of operating elements and menus	3.3
3.3 Display.....	3.6
3.3.1 Frequency display.....	3.7
3.3.2 Level display	3.8
3.3.3 Offset display, TUNING	3.9
3.3.4 IF spectrum (option).....	3.10
3.3.5 DATA lamp.....	3.10
3.3.6 Symbols	3.11
3.3.7 Status and error messages.....	3.12
3.4 Direct keys	3.13
3.4.1 MOD key (modulation modes)	3.13
3.4.2 BW key (bandwidths)	3.13
3.4.3 MGC-SQU-TONE keys and the VAR potentiometer	3.14
3.4.4 ATT key (attenuator)	3.15
3.4.5 AFC key (automatic frequency control)	3.16
3.4.6 LEV key (level indicator)	3.16
3.4.7 SAVE and RCL keys (memory functions).....	3.16
3.5 Decimal keypad.....	3.17
3.6 Spinwheel (rotary pulse generator).....	3.17
3.7 Keys for selecting the spinwheel functions	3.17
3.8 Memory functions.....	3.18
3.9 Menu-control keys.....	3.18
3.9.1 Softkeys	3.18
3.9.2 Escape (ESC)	3.18
3.9.3 Select key (SEL)	3.18

3.9.4 Relationship between the FRQ, MEM, SEL and LOCK keys 3.19

3.10 TEST key 3.19

3.11 ON/OFF switch..... 3.19

3.12 Contrast control..... 3.19

3.13 VAR pot (MGC, SQU, TONE) 3.19

3.14 Volume potentiometer 3.20

3.15 Headphone connector..... 3.20

3.16 POP-UP editor 3.21

 3.16.1 Softkeys in the editor window 3.22

3.17 Changing configuration parameters..... 3.23

3.18 Softkey menus 3.24

 3.18.1 M-SCAN..... 3.25

 3.18.1.1 M-SCAN - CONFIG 3.26

 3.18.1.2 M-SCAN - CONFIG - DELETE 3.28

 3.18.2 F-SCAN..... 3.29

 3.18.2.1 F-SCAN - CONFIG 3.30

 3.18.2.2 F-SCAN - CONFIG - SUPP 3.31

 3.18.3 D-SCAN (option) 3.32

 3.18.3.1 D-SCAN CONFIG 3.33

 3.18.3.2 D-SCAN cycle..... 3.34

 3.18.3.3 Spectrum display NORM (normal)..... 3.34

 3.18.3.4 Spectrum display NORM with squelch on 3.35

 3.18.3.5 Spectrum display in STOP mode 3.35

 3.18.3.6 Spectrum display DIFF (differential mode) 3.35

 3.18.3.7 Spectrum display with BW ZOOM 3.36

 3.18.4 RX-CONF (receiver configuration)..... 3.36

 3.18.4.1 ANT (antenna) 3.37

 3.18.4.2 MEASURE (configuration of measuring time parameters)..... 3.38

 3.18.4.3 AF configuration..... 3.39

 3.18.4.4 SYSTEM menu 3.40

 3.18.4.5 TEST 3.43

 3.18.5 DISPLAY (display variants)..... 3.45

 3.18.5.1 IF-PAN (IF panorama) 3.47

 3.18.5.2 LEVEL BAR (level measurement) 3.49

 3.18.5.3 TONE (signal tone; pitch depends on the signal level) 3.50

 3.18.5.4 FRQ (frequency) 3.51

 3.18.6 SETUP 3.51

 3.18.6.1 KEYS 3.52

3.18.6.2 MESSAGE	3.53
3.18.6.3 POWER	3.54
3.18.6.4 REF	3.54
3.18.6.5 AUX.....	3.55
3.18.6.6 REMOTE (remote control)	3.56
4 Remote control	4.1
4.1 Introduction	4.1
4.2 Brief instructions.....	4.1
4.2.1 Remote control via RS232 interface	4.1
4.2.2 Remote control via LAN interface (option).....	4.2
4.3 Configuring the remote control.....	4.2
4.3.1 Setting the IP-A and port number	4.2
4.4 Structure and syntax of the device messages	4.3
4.4.1 SCPI introduction	4.3
4.4.2 Structure of a command.....	4.3
4.4.3 Structure of a command line	4.7
4.4.4 Responses to queries	4.8
4.4.5 Parameters.....	4.9
4.4.6 Overview of syntax elements.....	4.12
4.5 Description of commands.....	4.13
4.5.1 Notation.....	4.13
4.5.2 Common commands.....	4.15
4.5.3 ABORt subsystem.....	4.18
4.5.4 CALCulate subsystem	4.19
4.5.5 DIAGnostic subsystem.....	4.24
4.5.6 DISPlay subsystem.....	4.27
4.5.7 FORMat subsystem	4.33
4.5.8 INITiate subsystem	4.37
4.5.9 INPut subsystem	4.38
4.5.10 MEASure subsystem	4.40
4.5.11 MEMory subsystem	4.42
4.5.12 OUTPut subsystem.....	4.46
4.5.13 ROUTe subsystem.....	4.54
4.5.14 SENSE Subsystem	4.58
4.5.15 STATus subsystem.....	4.96
4.5.16 SYSTem subsystem	4.101
4.5.17 TEST subsystem.....	4.109
4.5.18 TRACe subsystem	4.110

4.5.19 TRIGger subsystem	4.119
4.6 Device model and command processing	4.122
4.6.1 Remote client	4.123
4.6.2 Data memory	4.126
4.7 Status reporting system	4.127
4.7.1 Structure of an SCPI status register	4.128
4.7.2 Overview of the status registers.....	4.130
4.7.3 Description of the status registers	4.131
4.7.3.1 Status Byte (STB) and Service Request Enable Register (SRE).....	4.131
4.7.3.2 IST flag and Parallel Poll Enable (PPE) register	4.132
4.7.3.3 Event Status Register (ESR) and Event Status Enable (ESE) register	4.133
4.7.3.4 STATus:OPERation register	4.134
4.7.3.5 STATus:OPERation:SWEEPing register.....	4.135
4.7.3.6 STATus:QUEStionable register	4.136
4.7.3.7 STATus:TRACe register	4.137
4.7.3.8 STATus:EXTension register	4.138
4.7.4 Use of the Status Reporting System.....	4.140
4.7.4.1 Service request, making use of the hierarchy structure	4.140
4.7.4.2 Query by means of commands.....	4.141
4.7.4.3 Error-queue query.....	4.141
4.7.5 Resetting values of the status reporting system	4.142
5 Maintenance and Troubleshooting.....	5.1
5.1 Maintenance.....	5.1
5.1.1 Alignment of the 10-MHz reference oscillator crystal in the IF section.....	5.1
5.1.2 Re-establishing the original state, coldstart	5.1
5.1.3 Firmware Update	5.1
5.2 Troubleshooting	5.2
5.2.1 Accessories.....	5.2
5.2.2 Error messages.....	5.3
5.2.3 List of modules	5.4
5.2.4 Module exchange.....	5.5
5.2.4.1 Opening the unit	5.5
5.2.4.2 DC/DC converter	5.6
5.2.4.3 RAM expansion / Li-battery	5.7
5.2.4.4 Processor module	5.8
5.2.4.5 Front panel control unit and LCD.....	5.9
5.2.4.6 Preselection, frontend, IF section, IF-panorama (option)	5.12
5.2.4.7 Cable plan.....	5.14

5.2.4.8 RS232 interface	5.15
5.2.5 Maintenance support	5.16
Annex A (RS232 Interface)	A.1
Characteristics of the RS232 interface	A.1
RS232 standard mode	A.1
Setting parameters.....	A.1
Null modem cable	A.1
Binary transmission with byte escaping	A.2
RS232 PPP mode	A.3
Setting parameters.....	A.3
Null modem cable	A.3
Installation of a PPP connection under WindowsNT	A.4
Installation of a PPP connection under Windows 95/98/ME	A.6
Installation of a PPP connection under Windows 2000	A.8
Installation of a PPP connection under Windows XP	A.11
Installation of a PPP connection under Linux	A.14
Testing the protocol on the low-level	A.15
Testing the protocol on the EB 200 command level	A.15
Annex B (Error Messages)	B.1
Warnings, component failures and device-dependent info.....	B.1
Error messages of the queue query.....	B.4
SCPI-specific error messages.....	B.4
Device-specific errors.....	B.9
System errors.....	B.9
Message "OUT OF MEMORY"	B.9
Error hierarchy	B.10
Annex C (Functions and Commands).....	C.1
Remote and manual control functions	C.1
Basic functions.....	C.1
MSCAN	C.2
Memory functions.....	C.4
FSCAN	C.5
FSCAN SUPP	C.6
DSCAN.....	C.7
Receiver configuration	C.8
Measuring functions.....	C.9

System	C.10
Test	C.11
Display	C.12
IFPAN.....	C.13
Messages.....	C.14
Operating elements.....	C.15
LAN Interface	C.16
RS232 interface (PPP).....	C.16
RS232 interface (standard).....	C.17
Rear panel interfaces.....	C.17
Power source	C.18
Data formats.....	C.18
Trace.....	C.18
Status reporting - operation	C.19
Status reporting - operation - sweep.....	C.20
Status reporting - extension	C.20
Status reporting - questionable	C.21
Status reporting - trace	C.21
Annex D (Programming Examples).....	D.1
Annex E (Measuring Functions)	E.1
Detectors	E.1
CONTINUOUS measuring mode.....	E.4
Measuring time.....	E.5
PERIODIC measuring mode.....	E.6
Measuring time different from DEFAULT	E.6
Annex F (Datagram Communication).....	F.1
General.....	F.1
Addressing	F.1
Configuration.....	F.1
Protocol	F.1
Header	F.2
GenericAttribute	F.3
TraceAttribute.....	F.4
FScanTrace.....	F.6
MScanTrace.....	F.7
DScanTrace	F.8

AUDio.....	F.9
IFPan.....	F.11
FASTLEVCW	F.11
LIST.....	F.11
CW	F.11
Remote commands	F.12
Annex G (Coverage Measurement)	G.1
Operating modes.....	G.1
Single-channel measurement	G.1
Multi-channel measurement (triggered scan)	G.1
Measuring times.....	G.3
Triggering.....	G.4
Externally triggered measurement.....	G.4
Internally triggered measurement	G.4
Timer-triggered measurement	G.5
Data output.....	G.5
Single-channel measurement	G.5
Multi-channel measurement (triggered scan)	G.5
Annex H (Field Strength Measurement).....	H.1
1. Manual operation	H.1
Selecting the antenna	H.1
Displayed parameters.....	H.1
Softkeys	H.2
Numerical field strength display	H.2
Field strength display in DSCAN.....	H.3
2. Remote control.....	H.4
2.1 Sensor functions	H.4
2.2 Data output.....	H.4
3. Tool for handling antenna factors	H.5
3.1 Starting up the tool.....	H.5
3.2 Description of functions.....	H.6
General functioning.....	H.6
Creating a characteristic data set	H.6
Importing and exporting the antenna data - with OPEN and SAVE	H.7
Loading and saving the antenna data – with LOAD and STORE.....	H.7
Integrated help	H.8
Generation of characteristic-lines data in the user-data dialog.	H.9

Graphical representation in the view Window	H.10
Graphical representation of the K-factors of the antenna HE200.....	H.11
3.3 Upgrading the browser to Java 2 standard.....	H.11
Annex I (Digital IF Output).....	I.1
Digital IF output at the unit's rear panel.	I.1
Bandwidths and scanning rates	I.1
Data output via a DSP of the Motorola 563xx-family.	I.2
Configuration of the ESSI0 in the DSP 563xx.....	I.2
Data output to a personal computer.....	I.2
Annex J (Channel spacing DSCAN - FSCAN)	J.1
DSCAN principle	J.1
Previous state (DSCAN)	J.2
New state (DSCAN)	J.3
FSCAN principle.....	J.5
Annex K (Dynamic IP address RARP).....	K.1
Interface Description.....	4052.2000.01 SB
Test Instruction	4052.2000.01 T
Figures	
Fig. 2-1: Rear view	2.1
Fig. 2-2: Speaker jumper.....	2.2
Fig. 3-1: Front view.....	3.1
Fig. 3-2: Display	3.6
Fig. 4-1: Tree structure of the SCPI command system using the SENSE system by way of an example	4.4
Fig. 4-2: Device model with remote control.....	4.122
Fig. 4-3: Structure of a remote client within the firmware.....	4.123
Fig. 4-4 : Status register model	4.128
Fig. 4-5: Overview of status registers.....	4.130

2 Preparation for Use

2.1 Installation

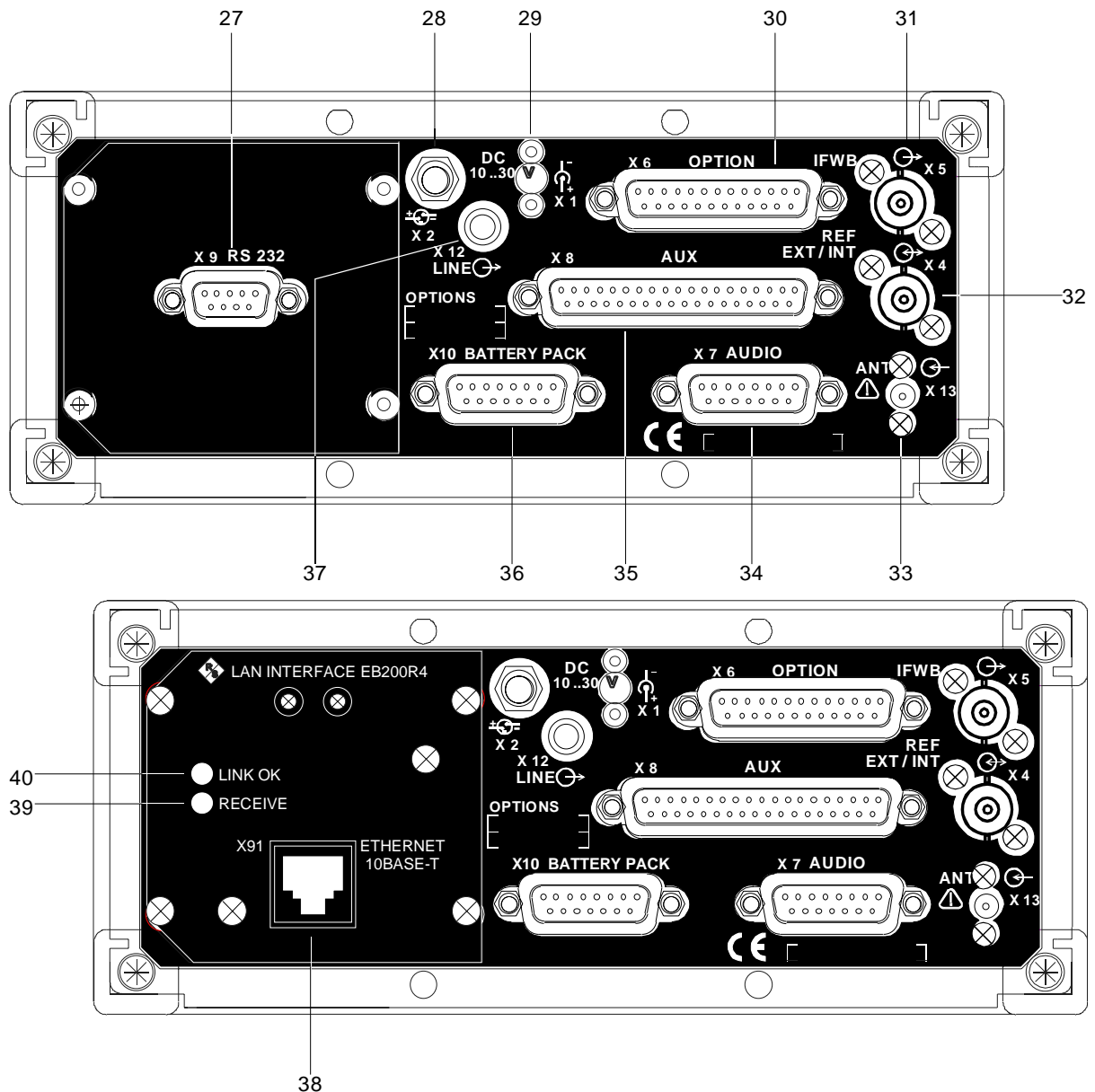

Fig. 2-1: Rear view

Item	Designation	Function
27	X9 RS 232	Connection for serial remote control RS-232 Sub-D connector, 9 pole
28	X2 DC 9 ... 30 V	Connection for battery belt (plugged-on battery pack will not be charged)
29	X1 DC 9 ... 30 V	Connection for external DC power supply (plugged-on battery pack will be charged)

Item	Designation	Function
30	X6 OPTION	Connection for external digital panoramic display unit (option) Digital IF Output, connection for software update
31	X5 IFWB	IF output, wide (10.7 MHz \pm 5 MHz) Connection for panoramic display unit BNC connector, 50 Ω
32	X4 REF EXT/INT	Input for external reference signal or output for internal reference signal 10 MHz Selectable in menu SETUP-REF BNC connector, $R_i = 500 \Omega$, $R_a = 50 \Omega$
33	X13 ANT	Antenna input for rack installation (to be selected internally) SMA connector, 50 Ω
34	X7 AUDIO	Audio output signals; signal level External speaker output by setting of the internal jumpers
35	X8 AUX	Universal connectors Antenna number; control commands for external options; digital control inputs; digital AF for DAT recorder
36	X10 BATTERY PACK	Connection for battery pack
37	X12 LINE	Audio output for left and right stereo channel 3.5-mm connector
38	X91 ETHERNET 10BASE-T	Connection for serial remote control LAN Western socket
39	RECEIVE	LED indicator signals reception of data via LAN interface
40	LINK OK	LED indicator signals that the LAN connection is OK

2.2 Wiring

For installation of the EB200 in a rack there is connector X13 available for connecting the antenna (antenna connector can be internally selected).

The external speaker output is activated by setting an internal jumper which automatically sets the internal speaker out of order.

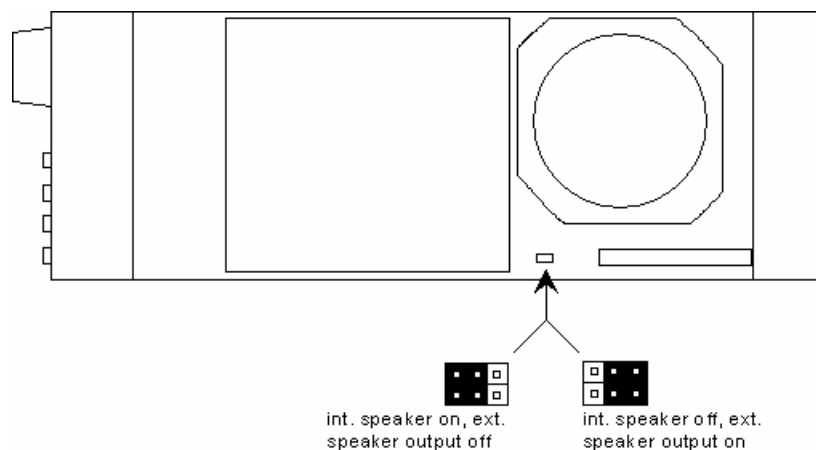

Fig. 2-2: Speaker jumper

2.3 Pin assignment of the connectors

For the pin assignment of the connectors refer to interface description 4052.2000.01 SB in the annex.

2.4 Operation with Battery Pack EB200BP

The battery pack incorporates two 12V nickel metal hydride accumulators Energizer NJ1020.

It can be charged via incorporated power supply input or via connector DCX1 at the rear panel of the EB200, while the unit is on or off. The accumulators are charged one after another.

Before starting operation, the state of the accumulators must be checked by pressing 2. If required, the accumulators must be charged.

If the accumulators are charged, the LEDs 25, 50, 75 and 100 are on after pressing 2 indicating the existing capacity.

If the accumulators are discharged the LED at 25 is flashing after pressing 2.

If the accumulators are over-discharged, all LEDs remain off after pressing 2. This is indicated in the menu SETUP POWER by NOT FIT.

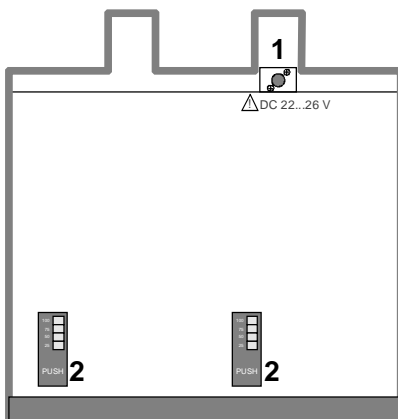

Over-discharged accumulators can only be charged when the EB200 is switched off or directly via the connector at the battery pack (1).

If charging doesn't take place (after a charging period of 1 hour there is no capacity change being indicated after pressing 2) the accumulators must be taken out and put in again by exchanging positions.

Note:

If the unit can't be operated despite max. capacity being indicated there can be an erroneous reaction of the accumulator controller. Possible remedy: The accumulators must be taken out and put in again by exchanging positions.

Operation with only one accumulator is also possible.

Charging can only take place at a temperature range of 0°C to +45°C.

Charge voltage range : +22V to +26V

Discharge temperature range : -10°C to +55°C

Storage temperature range : -20°C to +55°C

Self discharge increases heavily with higher storage temperatures.

The SETUP POWER menu shows the dc power supply source of the EB200 with the status of the accumulator and the remaining operating time of the battery pack at the actual power consumption under the total capacity of accumulator 1 and 2.

The displayed accumulator status might not be accurate if partly discharged accumulators are charged several times. The correct accumulator status is displayed only when the accumulators were discharged and charged completely.

The display illumination consumes power intensively. The illumination can be set to one of seven levels. There is also an automatic time-off that can be set so that the illumination switches off after a certain period of time (DISPLAY CONFIG menu). It switches on again when the EB200 is operated via front panel.

2.5 Operation in a vehicle

Operation of the EB200 in a vehicle is only permitted with the 12 V-to-24 V adapter.

2.6 Image of the Display in the Internet Browser

The display of the EB200 can appear in the Internet Browser via LAN.

For this purpose EB200 and personal computer must be connected through the same network.

- Enter the LAN address of the EB200 (see also 3.18.6 REMOTE (remote control)) and additionally :81 into the address field of the Browser. The image of the EB200 display appears in the Browser.

Example:

150 KHZ	FM	MGC OFF	SQU -10	TONE OFF	ADDR3
OFF	ADDRESS: 089.010.011.028		LAN		
AFC	PORT: 5555				
FAST	SUBNETMASK: 255.000.000.000				
333	GATEWAY: 089.010.015.070		SETUP		
					REMOTE
					APPLY

Enter into the address field of the Browser : **http://89.10.11.23:81**

The image of the EB200 display in the Internet browser is updated every 2 seconds.

3 Operation

3.1 Description of the front panel

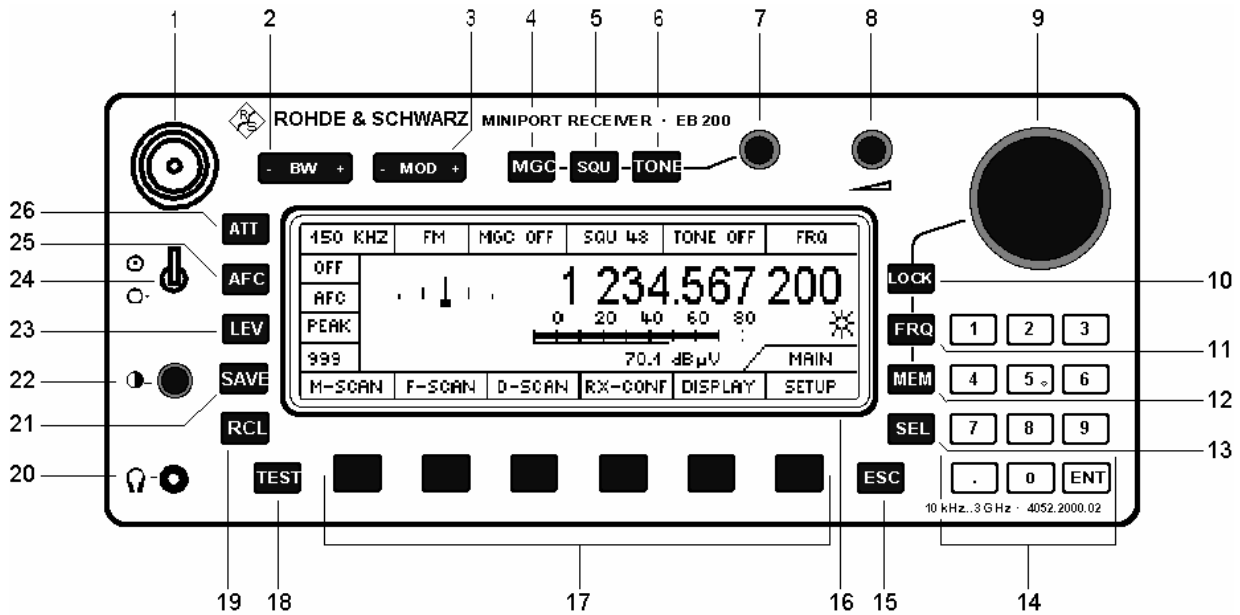

Fig. 3-1: Front view

Table 3-1: Controls and displays

Item.	Designation	Function
1	N-connector	Antenna connection
2	BW	Bandwidth selection
3	MOD	Selection of modulation mode FM, AM, PULSE, CW, USB, LSB or IQ
4	MGC	Switches MGC function on or off. Adjustments with potentiometer (7).
5	SQU	Switches the squelch function on or off. Adjustments with potentiometer (7).
6	TONE	Switches the tone function on or off. Adjustments with potentiometer (7).
7	VAR pot	Potentiometer for adjusting the values of MGC, SQU and TONE.
8	Volume control	Volume control for headphones, loudspeaker and loudspeaker-output on the rear panel
9	Spinwheel	Selects frequency, memory location or configuration parameters
10	LOCK	Key for enabling or disabling the spinwheel function
11	FRQ	Key for entering receive frequencies
12	MEM	Key for selecting the memory location number (0 to 999)
13	SEL	For selecting parameters in the configuration menu
14	Decimal keypad	For entering values into the editor, keys 0 to 9, decimal point and storage in the current selection with the ENT key. With the keys FRQ, MEM, MGC, SQU and TONE, the value is taken from the editor and stored directly.
15	ESC	Closes editor or temporary window or for moving a level upwards in the menu tree.

Item.	Designation	Function
16	Display	The display is subdivided into the working area and the softkey area and also into areas for direct functions, VAR pot functions, menu names, spinwheel functions and the selector (see "Display" on page 5)
17	Softkeys	Function depends on the menu status. The key lettering is provided by the field above in the display.
18	TEST	Self-test is performed while the key is held down.
19	RCL	Recalls values from a memory location to the receiver
20	Headphone connector	Connector for headphones
21	SAVE	Saves receiver values to a particular memory location
22	Contrast control	Controls display contrast
23	LEV	Level display (PEAK, AVG, FAST)
24	ON/OFF switch	Switches the internal power supply on or off
25	AFC	Switches the AFC function on or off
26	ATT	Function for connecting the 30 dB attenuation path (on, off, and auto)

3.2 Overall view of operating elements and menus

MOD

Selects modulation mode FM, AM, PULSE, CW, USB, LSB, IQ

BW

Selects IF bandwidth

MGC - SQU - TONE

Selects the manual gain control, squelch and tone function; values can be varied with the VAR potentiometer

ATT

Toggles between 30 dB attenuation ON, OFF or AUTO

AFC

Switches automatic frequency control on or off

LEV

Toggles between PEAK, AVG or FAST level display

SAVE

RCL

Writes to memory locations with SAVE, reads from memory locations with RCL

TEST

Quick test

1 2 3
 4 5 6
 7 8 9
 . 0 ENT

For writing values and storing with ENT as currently selected parameter.

The keys FRQ, MEM, MGC, SQU, TONE, SAVE and RCL transfer the value from the editor and store it directly.

LOCK

FRQ

MEM

Disable spinwheel functions with LOCK

Select frequencies with spinwheel function FRQ

Select a memory location with spinwheel function MEM

SEL

Selects a parameter in the configuration menu

ESC

For going a level higher in the menu tree or escaping from the editor



The functions of softkeys F1 to F6 depend on what menu has been selected. The currently selected function is displayed by the LCD.

MAIN menu**M-SCAN** (scan with stored values)

RUN (starts scan)
 STOP(stops scan)
 SUPP (suppresses memory location)
 CONFIG (selects configuration menu)
 RUN (starts scan)
 ACTIVATE (activates memory location)
 SUPP (suppresses memory location)
 DELETE (clears current memory location or all memory locations)
 RX <-> MEM (swaps the receiver parameters with contents of memory location)

F-SCAN (frequency scan)

RUN (starts scan)
 STOP (stops scan)
 SUPP (suppresses frequency range)
 CONFIG (go to configuration menu)
 RUN (starts scan from current frequency)
 SUPP (suppressed frequency ranges)
 SORT (sorts suppressed frequency ranges)
 DELETE (deletes current line from the table)
 DEL ALL (deletes the whole table)

D-SCAN (RF spectrum display, option)

NORM DIFF (differential or normal spectrum)
 RUN STOP (sweep mode: listening mode)
 BW ZOOM (change-over to bandwidth-zoom mode)
 RND 60 (Y-scaling for 20, 40, 60, 80 dB of the spectrum display)
 CONFIG (change into the configuration menu)
 NORM DIFF (normal or differential display of the spectrum)
 MAX (max. hold in the spectrum display)
 CLRWRITE (clear write in the spectrum display)
 RNG 60 (Y-scaling for 20, 40, 60, 80 dB)
 |<- ->| ^ (start, stop, marker frequency) or <-> >|< ^ (span- center-, marker frequency)

RX-CONF (receiver configuration)

ANT (antenna number and code)
 MEASURE (measuring time and cycle)
 CONTIN (continuous measurement)
 PERIODIC (periodic measurement)
 AF (AF parameters SPEAKER, TONE, BALANCE)
 SYSTEM (displays system data)
 PROTECT (password protection)
 EDIT PW (enter password)
 DEL PW (delete password)
 SW OPT (display and installation of software options)
 INSTALL (installation of software options)
 RESET (reset to the default values)

TEST (self-test)

LONGTEST (starts overall test)

DISPLAY (menu display modes)

- DEFAULT (selection of display setting)
- IF-PAN (IF panorama display)
- LEVEL (level display as bar or numerically)
- TONE (signal tone whose pitch depends on the signal level)
- CONFIG (setting the selected display mode)
- MORE (more menus)

- FRQ (large frequency display)
- CONFIG (setting of the selected display mode)
- MORE (back to previous menus)

SETUP

- KEYS (characteristics of spinwheel and keys)
- MESSAGE (configuration of the acoustic and optical messages)
- POWER (display of charging status)
- REF (internal or external reference frequency)
- AUX (configuration of the AUX port parameters)
- REMOTE (configuration of the remote-control parameters)
 - STANDARD (simple ASCII protocol through the RS232 interface)
 - RS232 PPP (point-to-point protocol through the RS232 interface)
 - APPLY (transfer of the parameters)
 - YES (acknowledgement of the parameter transfer)
 - NO (refusal of the parameter transfer)

3.3 Display

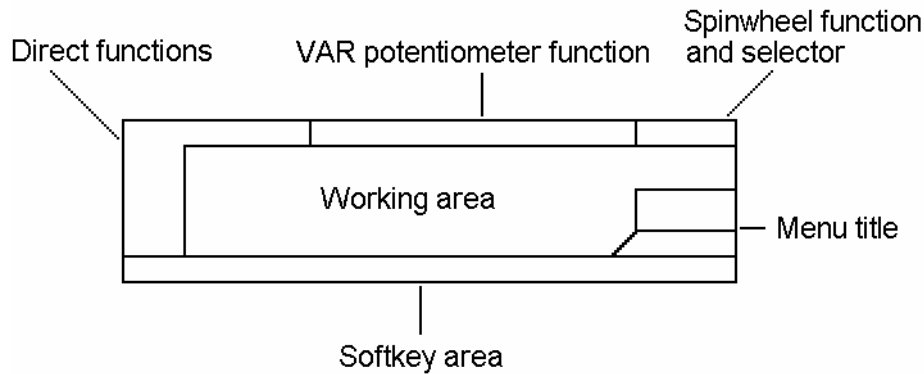

Fig. 3-2: Display

Working area

The working area can be expanded for certain, display-intensive menus or for panorama displays, but the direct-function fields, the VAR potentiometer functions and the display area for the spinwheel functions will be partially or completely obscured.

Direct functions

The currently selected state of each key function (except softkeys) is displayed in an LCD window next to or below the key in question.

VAR pot functions

At the top of the display, there are three fields for the MGC, SQU and TONE functions. Their values can be adjusted with the digital VAR potentiometer.

Spinwheel functions

In the upper right hand corner of the display, there is a field in which the current function of the spinwheel (FRQ, MEM, LOCK) is displayed. If in a submenu for configuring a parameter, the spinwheel function is set to this parameter, the short designation or the symbol for this parameter (eg T_DWELL, T_NOSIG, CYCLES etc) is displayed in this field.

Softkey area

The six fields that provide the labelling for the softkeys below are provided for every menu status.

The softkey bar may be temporarily obscured by status and error messages.

Menu names

On the right-hand side of the screen above the softkey bar, there is a window for the name or designation of the menu that is currently activated. The menu name always corresponds to the designation of the softkey that was used to activate the menu. If you are in a second or third level submenu, the names of the menus above are displayed above the menu name window.

3.3.1 Frequency display

The frequency display can be presented in different sizes but always at the same position in the working area of the display. When the IF-panorama option has been activated, the small frequency display is automatically selected.

All frequencies are displayed in MHz without a unit as standard; the step frequency is displayed in kHz with a unit.

The receive frequency is always displayed with six places after the decimal point.

The start and stop frequencies are displayed with only three places after the decimal point.

To make the numbers easier to read, their digits are marked off in groups of three.

3.3.2 Level display

Level-bar display

The top bar shows the signal level with 1 dB resolution.

The lower bar shows the squelch threshold with 1 dB resolution.

The lowest value of the level scale is configurable with the parameter LOW BAR LIMIT in steps of -30, -10 and 10 dB μ V.

Scaling of the level-bar display with ATT OFF

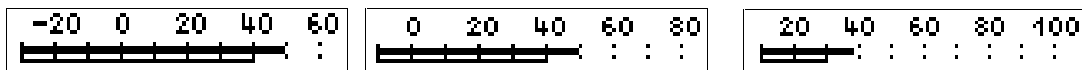

LOW BAR LIMIT: -30 dB μ V

-10 dB μ V

10 dB μ V

Scaling of the level-bar display with ATT ON

With cut-in attenuator the scale moves by 30 dB to the top. This indication makes also clear that the attenuation is switched on if ATT AUTO is set.

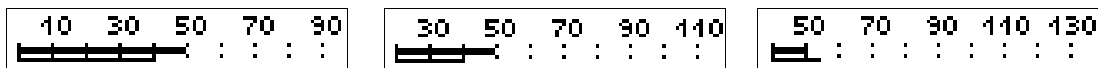

LOW BAR LIMIT: -30 dB μ V

-10 dB μ V

10 dB μ V

Large level-bar display

The top bar shows the signal level with 1 dB resolution.

The lower bar shows the squelch threshold with 1 dB resolution.

The scaling of the large level-bar display and the small level-bar display is the same in reference to the LOW BAR LIMIT and the ATT setting.



Wide level-bar display

For the operation mode TONE the level scale is widened around a tunable center.

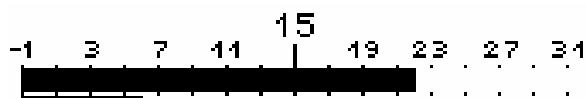

Numeric level display

The numeric level value is also displayed in different sizes. The value is displayed in dB μ V with a decimal point (resolution 0.1 dB).



At bandwidths \leq 0.6 kHz, also level values \leq -20 dB μ V are displayed.

3.3.3 Offset display, TUNING

The offset display is configurable and can be presented as a numerical display or in the form of a tuning meter (TUNING).

Symbolic offset display



The bar, which is 5 pixels wide and 4 pixels high, moves to the right or the left from its central position depending on whether there is a positive or negative frequency offset (\pm 0.5 bandwidth).

The display is for the selected bandwidth and can only be used for qualitative assessments.

Numerical offset display

TUNING
-1.50 KHZ

The display is in kHz with two digits after the decimal point.

3.3.4 IF spectrum (option)

The width of the IF panorama display can be adjusted by the SPAN parameter.

The setting range is 150 Hz up to 1000 kHz in 17 steps. Additionally the width of the IF-panorama display can be set to COUPLED. In that case the width of the IF-panorama display corresponds always to the set IF-bandwidth.

Appearance of the IF spectrum in the IF-PAN display

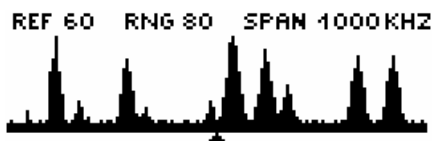

Above this panorama display, the reference level REF, the displayable level range RNG and the current frequency span are displayed. The reference level corresponds to the highest display limit. The lowest display limit results from REF minus RNG.

With switched on squelch a horizontal line is indicated according to the squelch value in the spectrum. This line can be used for the measuring of the level of individual signals.

The level range RNG is represented by a vertical resolution of 30 pixels. The frequency span SPAN is represented by a horizontal resolution of 127 pixels.

Appearance of the IF spectrum in the DEFAULT display

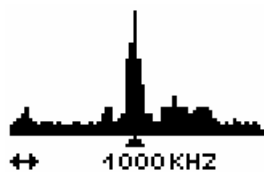

Below this panorama display the current frequency span (SPAN) is indicated.

The level range RNG is represented vertically with a resolution of 30 pixels. The frequency span SPAN is represented horizontally with a resolution of 63 pixels.

3.3.5 DATA lamp

DATA Indicates a data transmission in progress

Note:

The DATA lamp (remote data traffic) only appears in the KEYLOCK menu.

3.3.6 Symbols

Signal > threshold display

The lamp symbol  only appears above the menu name in the working area if the receive signal threshold is exceeded.

Overdrive display

 This symbol flashes when the IF section is overdriven. Level measurement is possible without overdriving to approx. 85 dBµV (at ATT ON 113 dBµV). If the attenuation is set on 'ATT AUTO', the 30-dB attenuator switches on not before the overdriving limit of approx. 85 dBµV and with a hysteresis of approx. 7 dB it switches off again.

Note:

The overdrive indication is only possible with IF sections that are shown as IF SECTION.2 in the RX-CONF:TEST menu.



Note:

This display is obscured by the menu names when lower-level menus are selected..

Measuring mode display

At the position of the overdrive display, the currently active measuring mode of the unit may also be displayed alternatively. The relevant settings are available via the menu RX-CONF – Measure.

- No display The measuring time has been set to **DEFAULT** and as measuring mode **continuous (CONTIN)** measurement has been selected.
- P** The measuring time has been set to **DEFAULT** and as measuring mode **periodic (PERIODIC)** measurement has been selected.
- M C** A specific measuring time has been set and as measuring mode **continuous (CONTIN)** measurement has been selected.
- M P** A specific measuring time has been set and as measuring mode **periodic (PERIODIC)** measurement has been selected.

Memory location status display (information to the right of the memory location number)

- empty not set
- full not set
- empty set
- full set

FULL refers to the memory location filled with receiver parameters

NOT SET corresponds to 'suppressed', SUPP softkey in the M-SCAN menu

SET corresponds to 'activated', ACTIVATE softkey in the M-SCAN - CONFIG menu

3.3.7 Status and error messages

120 KHZ	FM	MGC OFF	SQU 48	TONE OFF	FRQ
OFF					
AFC					
PEAK					
999					
CHECK EXTERNAL REFERENCE					QUIT

A window for error messages can be temporarily opened by means of the softkeys. Depending on the configuration, the window will remain open for a certain time or permanently. However, you can close the window whenever you want with the QUIT softkey.

The ESC and ENT keys can also be used to close the window.

3.4 Direct keys

Note:

When you press the keys MOD, BW, MGC, SQU, TONE, ATT, AFC and LEV once, the next selection is activated. The displayed window shows the already changed setting. Thus the unit can be operated blindfold.

3.4.1 MOD key (modulation modes)

Selection of modulation mode by the + or – function of the key: FM, AM, PULSE, CW, USB, LSB, IQ

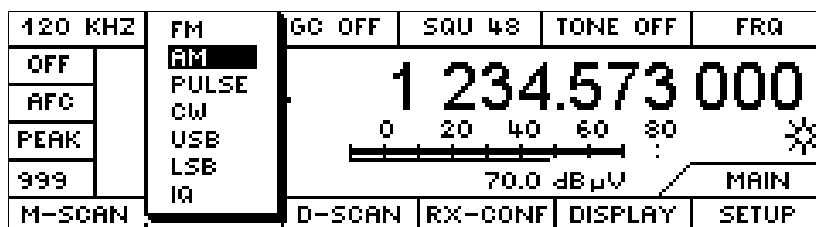

When you press this key, the pulldown menu shown below with a number of items for selection is displayed. When you press the key once, the next selection is activated. In a pulldown menu, the currently selected modulation mode is shown in inverse video.

When you press the key once again the next item is selected. There is no stop to the toggle function, so when the end of the menu is reached in either direction the next step leads to the opposite end of the menu.

The pulldown menu disappears after approx. 2 to 4 seconds or if any other key is pressed.

3.4.2 BW key (bandwidths)

IF bandwidth selection with the + function (larger bandwidths) and – function (smaller bandwidths) of the key

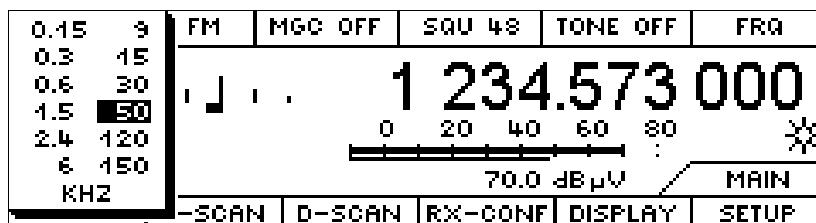

Just as with modulation modes, the bandwidth selection is shown in a pulldown menu. The currently selected bandwidth is shown in inverse video.

Stepping through the bandwidth selection stops at the highest and the lowest value.

3.4.3 MGC-SQU-TONE keys and the VAR potentiometer

All three functions can be turned on or off. In the ON state, a setting value can be assigned. This value can be adjusted with the VAR potentiometer (on the left next to the volume control).

The functions are independent and switching on one function need not necessarily have an effect on another.

The following applies to all three functions:

When you press a key (MGC, SQU or TONE), the function is turned on and, at the same time, the digital pot for adjusting the associated setting value is activated.

The lettering (MGC, SQU or TONE) and the presentation of the value in inverse video indicate that variation with the digital pot has been selected.

If the function has already been selected and the same key is pressed again, the function is turned off. The following is then displayed in the appropriate field:

MGC OFF (= AGC)

SQU OFF

TONE OFF

When you press a key, one of the three functions goes from the OFF-state to the ON-state and is simultaneously selected, the selection of one of the other two functions being cancelled.

The values are displayed in dB μ V.

MGC key

Switching the MGC function on or off (switch over from MGC to AGC)

MGC is short for Manual Gain Control (gain control by potentiometer).

AGC is short for Automatic Gain Control

The MGC or AGC status (corresponds to MGC off) is presented below the MGC key on the display.

If MGC is selected, MGC is displayed with a value between -30 and 110.

The unit of the MGC value is dB μ V.

SQU key

Turning the squelch function on or off

The SQU status is presented below the SQU key on the display.

If SQU is turned off, SQU OFF is displayed.

If SQU is turned on, SQU is displayed with a value between -30 and 110 (threshold value).

The unit of the SQU value is dB μ V.

TONE key

Turning the tone function on or off

The TONE status is presented below the TONE key on the display.

If TONE is turned off, TONE OFF is displayed.

If TONE is turned on, TONE is displayed with a value between -14 and 94 (tone reference value).

The unit of the TONE value is dB μ V.

-14 dB μ V = minimum level -30 dB μ V + 16 dB

94 dB μ V = maximum level at ATT ON 110 dB μ V - 16 dB

Starting from this value, the level scale is expanded in the range -15 to +15 dB and the level magnitude is represented by the pitch of a tone (0 dB corresponds to about 400 Hz). The TONE function is a frequency tone, proportional to the input level.

3.4.4 ATT key (attenuator)

Multiple toggle ON, OFF, AUTO for the function that connects the 30 dB attenuation path.

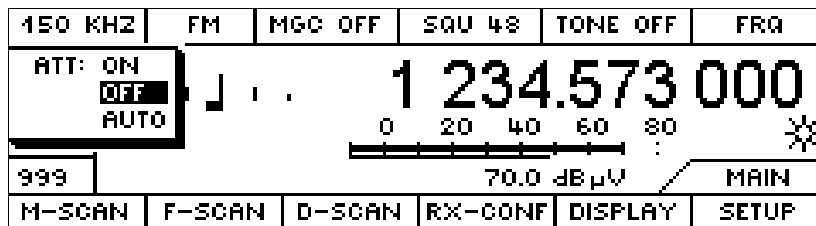

The selected function is displayed.

In the AUTO position the attenuation path is switched on immediately before the tuning limit of the IF unit is reached and with a hysteresis of 7 dB it is switched off again.

One can recognize the instantaneous condition by the scaling of the level bar indirectly. See also "Level display" on page 8.

3.4.5 AFC key (automatic frequency control)

Turning the AFC function on or off

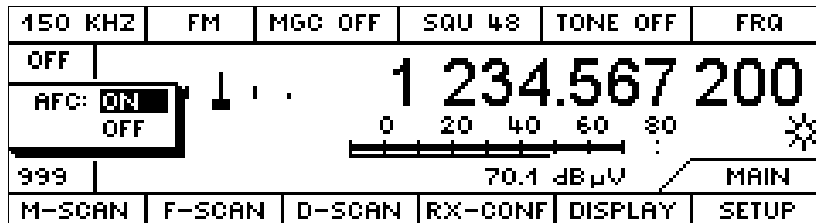

When the AFC is on, the lettering is in inverse video.

After pressing the AFC key (automatic frequency control) the frequency of the receiver is followed up automatically to a changing signal frequency. The range of the AFC corresponds approx. to the selected IF-bandwidth. At built up AFC the offset indication (TUNING) is centered. The AFC function can be activated at AM, FM and PULSE.

Note:

The AFC is only effective above a particular bandwidth-dependent signal level. With the squelch being switched on the signal level must be above the squelch response threshold.

3.4.6 LEV key (level indicator)

Multiple toggle PEAK, AVG, FAST

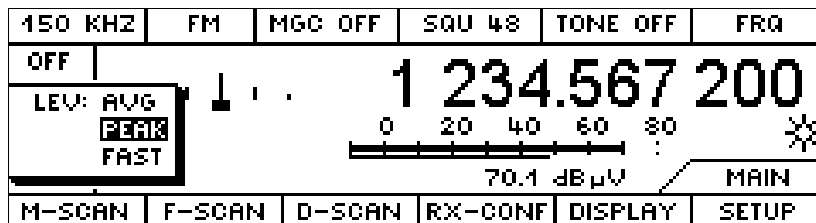

The selected function is displayed.

3.4.7 SAVE and RCL keys (memory functions)

Writing to and reading from memory locations

With **SAVE**, the receiver settings are transferred to the memory location. The configuration of the SAVE key determines on which memory location the settings are stored (see also "**ROLLKEY configuration**" on page 52).

With, **RCL** the contents of the memory location with the number shown in the MEM window are transferred to the receiver.

If a number was entered before SAVE or RCL were pressed, then this number will be interpreted as a memory location number (see also "KEYS" on page 52).

3.5 Decimal keypad

Keys 0 to 9, decimal point and Enter key (ENT)

The effect of pressing the **ENT** key is to store the value in the editor as the currently selected parameter.

As there is no CLR key and no +/- key, these functions are implemented as softkeys in the temporary editor (see "POP-UP editor" on page 21).

3.6 Spinwheel (rotary pulse generator)

The spinwheel excites 24 bursts per spin and has a magnetic indexing mechanism.

In the configuration menus, the spinwheel is used for the change of selected parameters.

The spinwheel is generally used to set receive frequencies in the menus. Different progressions can be selected in the menu SETUP: KEYS. For the tuning of the frequency in a channel spacing an increment per spinwheel burst can be defined through INCR VALUE.

3.7 Keys for selecting the spinwheel functions

FRQ and MEM are selection keys with a fixed parameter assignment. They also act as Enter keys for these parameters.

- FRQ** Key for entering receive frequencies
- MEM** Key for selecting the memory location (0 to 999)
- LOCK** Key for enabling and disabling the spinwheel functions

Example:

By entering the number 78 with the decimal keypad and then pressing the MEM key, you can select memory location 78. The frequency can also be selected independently at the same time with the spinwheel, if the FRQ field is active.

Pressing the MEM and FRQ keys only causes a switchover of the spinwheel function, if a numerical entry has not been made previously.

If the FREQ key is pressed whenever a receive frequency has already been selected then the receive frequency is rounded off to the next channel spacing. The channel spacing can be set in the menu SETUP: KEYS through parameter INCR VALUE (see also KEYS on page 52).

At the top right of the LCD, there is a field which displays the current status of the spinwheel function:

At this point, the designation of a configuration parameter can also be displayed (see "Select key (SEL)" on page 18).

If LOCK is displayed, the spinwheel has been deactivated. If you now turn the spinwheel, the display will flash.

3.8 Memory functions

If you want to modify the contents of a memory location, the contents of the memory location must be transferred to the receiver with RCL (see "SAVE and RCL keys (memory functions)" on page 16), modified with the hardkeys or softkeys in RX-CONF (see "RX-CONF (receiver configuration)" on page 36) and stored again with SAVE.

The SAVE and RCL (recall) keys are used to read and write receiver states from and to the 1000 memory locations.

The setting and resetting of memory locations is handled by softkeys in the M-CONF menu.

The display window for the memory locations also contains a symbol with features that indicate whether the memory location is full, or empty, or set, or not set, for polling (see "Symbols" on page 11).

3.9 Menu-control keys

The SEL key is used to select parameters in the configuration menu.

Toggle and increment or decrement functions can be operated by means of the spinwheel.

3.9.1 Softkeys

The functions of the softkeys are determined by the current menu status. The softkey labelling is provided by the LCD field above each key.

3.9.2 Escape (ESC)

When the ESC key is pressed once, one step is taken up the menu tree.

This key is used to abort the editor.

Temporary windows (eg error messages) are also closed.

3.9.3 Select key (SEL)

The SEL key is used to select parameters in the configuration menu.

When a configuration menu is entered, the selector always jumps to the parameter which was edited last.

The short designation of the selected parameter (eg F-START, F-STOP, F-STEP, T_DWELL, T_SIGNAL etc) is displayed in the spinwheel selector window, provided that the spinwheel functions have not been cancelled with LOCK.

If LOCK has been activated and the editor has been started by entering a number, the selector is nevertheless displayed in the spinwheel window provided that the editor is open.

If the spinwheel is turned in that state, LOCK flashes.

3.9.4 Relationship between the FRQ, MEM, SEL and LOCK keys

FRQ and MEM are selection keys with permanently assigned parameters. Their function does not depend on the menu status.

The SEL key is an alternative to the FRQ and MEM keys

Example:

If FRQ is pressed in a configuration menu, the selection of the current parameter is overridden and it becomes possible to tune the receive frequency with the spinwheel. When the SEL key is pressed, selection is switched back to the previous configuration parameter.

In every case, the LOCK key disables the spinwheel. The LOCK state does not have any influence on the SEL function.

3.10 TEST key

The "short test" is run while the key is held down.

During the "short test" an amplitude modulated line spectrum (64-MHz grid) is fed-in behind the antenna input and the receiver is tuned to the line frequency which is the closest to the current receive frequency. Then the complete receive-path from the antenna input of the tuner is measured up to the AF-processing and weighted.

If all data are within the permissible limits, the message "TEST OK SIGNAL PATH" is output. If the measured level is not in the expected range, the message "SENSITIVITY OUT OF RANGE" is output.

3.11 ON/OFF switch

The toggle switch turns the operating voltage to the EB200, which is generated by a DC/DC converter, on or off.

The backlit LCD indicates when the EB200 is ON.

The selected parameters are stored.

3.12 Contrast control

The contrast control is used to set the vertical reading angle for the LCD display, to adapt it to the workplace and to compensate for the temperature dependence of the LCD. This function cannot be altered from the menus.

3.13 VAR pot (MGC, SQU, TONE)

The digital potentiometer which has 24 switch positions per turn is used to vary the MGC, the squelch threshold and the tone values. The value in inverse video is the one that can be varied with the pot.

3.14 Volume potentiometer

The digital potentiometer which has 24 switch positions per turn is used to vary the AF level. The levels at the headphone connector, the integral loudspeaker and at the regulated AF-output on the rear panel can be adjusted.

The volume of the BEEP and the sound of the key click are configured separately in the SETUP-MESSAGE and SETUP-KEYS menu respectively (see "**SETUP**" on page 51).

3.15 Headphone connector

A 3.5-mm stereo banana socket for headphones is provided on the front panel. When the headphone is plugged in, the loudspeaker is not turned off automatically but it can be cut off by menu 'AF configuration' (see "AF configuration" on page 39).

3.16 POP-UP editor

When one of the decimal keys (0 to 9 and the decimal point) is pressed for the first time, a temporary EDIT window is displayed above the softkey bar; all numerical entries are shown in this window.

150 KHZ	PULSE	MGC OFF	SQU OFF	TONE OFF	ILLUM
OFF	DISPLAY MODE: NORMAL				
AFC	ILLUMINATION: STEP 8				
		SWITCH OFF: NEVER			
EDIT 5					DEFAULT
					CONFIG
+/-			←	ESCAPE	

The EDIT window does not have preferred values. An exception is the MHZ and the KHZ key. These two keys will only be displayed if the spinwheel function is connected to a frequency.

120 KHZ	FM	MGC OFF	SQU 48	TONE OFF	FRQ
OFF	1 234.567 000				
AFC	. . . ↓ . .				
EDIT 1234					*
+/-	MHZ	KHZ	←	ESCAPE	MAIN
					SETUP

If a time parameter was selected, the time units SEC and MSEC are presented as ENTER keys.

150 KHZ	FM	MGC OFF	SQU 48	TONE OFF	MTIME
OFF	MEASURE TIME: DEFAULT				
AFC	IF-PAN MODE: CLRWRITE				
EDIT 12					EX-CONF
					MEASURE
+/-	SEC	MSEC	←	ESCAPE	

While the editor window is open, you can continue to use the spinwheel to adjust the selected parameter (e.g. FRQ or F-START).

Value transfer with the ENT key

When the Enter key is pressed, the value becomes the value of the parameter displayed in the spinwheel selector window. Either FRQ or MEM is displayed in the spinwheel selector window or the name of a selected parameter from the configuration menu.

Value transfer with the FRQ, MEM, SQU, MGC, TONE, SAVE and RCL keys

The value can also be turned into the value of the parameter in question with one of these function-linked Enter keys.

3.16.1 Softkeys in the editor window

MHZ softkey

The basic unit of all frequencies is always MHz. From that this softkey has the same importance as the ENT key does.

KHZ softkey

The principal units in all menus are always MHz. To make kHz entries easier, a KHZ softkey has also been provided. Pressing the KHZ key multiplies the entered value by a factor of 10^{-3} and transfers it (Enter function). If the selected parameter is not a frequency, the KHZ softkey is disabled and not displayed.

SEC softkey

The basic unit of all times is always seconds. From that this softkey has the same importance as the ENT key does.

MSEC softkey

The basic unit of all times is always seconds. In order to facilitate the input of milliseconds, there is the MSEC softkey in addition. This causes that the entered value is multiplied by the factor 10^{-3} and taken over (enter function). If the selected parameter is not a time, no MSEC softkey appears then.

<- softkey

The arrow key is used to clear falsely entered characters.

ESC softkey

The ESC softkey as well as the ESC key closes the editor window without any value being transferred.

Sign change

By pressing the +/- softkey, you change the sign of a number.

3.17 Changing configuration parameters

A selected parameter can be changed in the F-SCAN, M-SCAN and D-SCAN configuration menus and in the SETUP submenus. Parameters can be selected by the SEL softkey.

Numerical and non-numerical parameters can be changed by the spinwheel and the decimal keypad.

In the case of non-numerical parameters, the digits referred to below are interpreted in the following way:

'0' corresponds to OFF

'1' corresponds to ON

'.' corresponds to the infinity sign (for example with the parameter CYCLES)

As the EB200 does not have any CURSOR keys, toggle and increment or decrement functions are implemented by means of the spinwheel.

In order to be able to also enter non-numerical parameters when the spinwheel is locked, the numbers 0, 1, 2, etc. refer to these parameters correspondingly. Thus by pressing a number and the ENT button a parameter is selected.

3.18 Softkey menus

The current menu is indicated indirectly by the display format.

The name of the menu will be found in a window above the SETUP softkeys.

POWER-ON menu

This menu display is shown for 30 s whenever the EB200 is turned on.

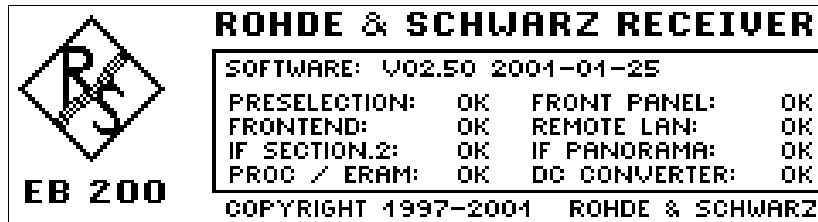

Note:

If the processor is supplied with expansion-RAM then PROC/ERAM will be displayed instead of PROCESSOR.

As soon as keys or knobs are used, the MAIN menu appears.

MAIN menu

The MAIN menu can be recognized at the MAIN menu title at the lower right-hand side, above the softkey area. According to configuration this menu can have a different appearance. Two variants are exemplary represented here. Further variations can be selected and configured in the DISPLAY submenu.

MAIN menu default setting

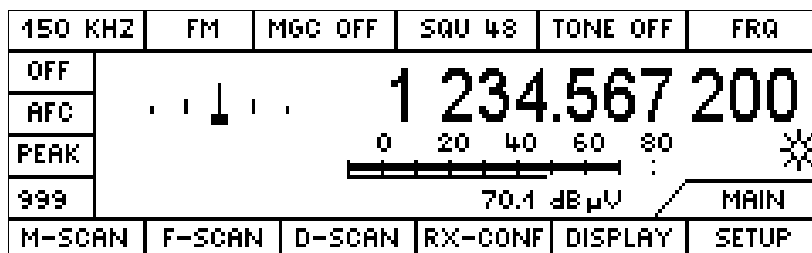

MAIN menu with DISPLAY-IF-PAN (option)

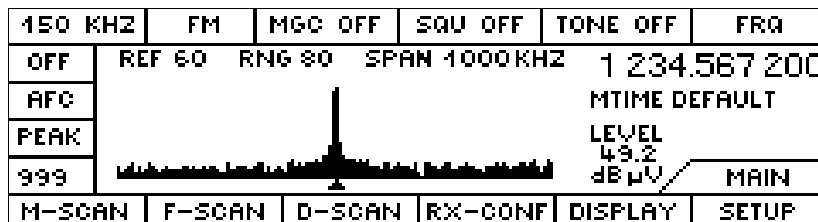

Further variations can be selected and configured in the DISPLAY submenu.

3.18.1 M-SCAN

The EB200 contains 1000 definable memory locations. Every memory location contains the essential receiver parameters such as frequency, modulation method, bandwidth, squelch, antenna number, attenuation and AFC. In the operation mode Memory Scan the stored and activated channels are scanned in a periodical way on occupancy. On the busy channels, the ones with a signal being higher than the current squelch threshold, the search run continues for a definable time. The effective squelch threshold can generally be set by the squelch potentiometer or loaded during the search run from every memory location.

This menu is obtained by pressing the M-SCAN softkey in the MAIN menu.

120 KHZ	FM	MGC OFF	SQU 40	TONE OFF	FRQ
AUTO	98.500 000				
AFC					
AVG	T_DWELL: 2.0S	0 20 40 60 80			**
0	T_NOSIG: OFF	47.7 dBµV			M-SCAN
RUN -	RUN +	STOP	SUPP		CONFIG

Softkeys

RUN-: Scan starts from current memory location, decreasing location numbers

RUN+: Scan starts from current memory location, increasing location numbers

Note:

If the current RUN key is in inverse video this tells you that an M-SCAN is being performed. If the RUN key is pressed and it is in inverse for only a short time then no memory location was set for this operation.

STOP: stops scan

SUPP: memory location with MEM number is suppressed or skipped

CONFIG: selects the M-SCAN CONFIG configuration menu

3.18.1.1 M-SCAN - CONFIG

This menu is obtained by pressing the CONF softkey in the M-SCAN menu.

120 KHZ	FM	MGC OFF	SQU 48	TONE OFF	CYCLES
OFF	MEM: FRQ 1 234.567 000		1 234.567 000		
AFC	MOD FM	SQ FROM MEM: ON			
AVG	BW 120 KHZ	T_DWELL: 2.0 S		M-SCAN	
999	SQ 48 ATT-OFF	T_NOSIG: OFF		CONFIG	
	ANT 0 AFC-OFF	CYCLES: 1			
RUN -	RUN +	ACTIVATE	SUPP	DELETE	RX<->MEM

Softkeys

- RUN-:** Scan starts from current memory location number, decreasing frequency, menu change after M-SCAN
- RUN+:** Scan starts from the current memory location number, increasing frequency, menu change after M-SCAN
- ACTIVATE:** Memory location with the number MEM-NO set for scanning
- SUPP:** Memory location with number MEM-NO is suppressed
- DELETE:** Branching to temporary pop-up menu with repeated scan (see "M-SCAN - CONFIG - DELETE" on page 28)
- RX <->MEM:** The receiver parameter values are swapped with the values in the memory location

Note:

Memory location contents can be edited best with the control elements of the receiver. In order to transmit the data from the memory location to the receiver and vice versa, beside the softkey RX<->MEM, the hardkeys SAVE and RCL are also available. See also memory function on page 18.

Memory location contents

- FRQ** Receive frequency
- MOD** Demodulation mode
- BW** Bandwidth
- SQ** Squelch OFF or squelch value
- ANT** Antenna number (controlled by CPU in stationary mode)
- ATT** Attenuation
- AFC** Automatic frequency control (only relevant for listen mode)

The following parameters are global and are **not** stored at any memory location:

- LEV** Level indicator (not relevant when M-SCAN is running)
- MGC/AGC** Gain control (depends on the current reception conditions)

Configuration of the M-scan-run parameters

The parameters T_DWELL, T_NOSIG and CYCLES can be selected with SEL and then varied with the spinwheel or entered in the editor and varied.

SQ FROM MEM	Squelch status and value from memory location:	ON / OFF
T_DWELL	dwel time:	0.0 to 10.0 s / infinity
T_NOSIG	further scan signal-controlled after pause:	OFF / 0.0 to 10.0 s

The hold time **T_NOSIG** can well be used to skip non-speaking times in radio communications. In order to control the dwell time by a signal of an occupied channel, the parameter **T_NOSIG** is required additionally. If a hold time is defined for the parameter **T_NOSIG**, the signal bit is queried during the normal dwell time **T_DWELL** in a periodical way. The signal bit corresponds to the signal on pin 6 of the audio connector X8 at the rear panel of the EB200 and indicates whether the instantaneous signal level is above the squelch value. If the signal bit disappears, the hold time is activated. After the hold time has elapsed the scanning will continue with the next frequency. If, however, the signal bit emerges during the hold time again, the hold time is stopped and the disappearance of the signal is waited for again. Thus the hold time behaves like a monoflop that can be retriggered and abort the normal dwell time **T_DWELL** early. If **T_NOSIG** is OFF after **T_DWELL** has elapsed the scanning will proceed with the next frequency independently from the state of the signal bit.

CYCLES	number of scan cycles:	1 to 1000 / infinity
---------------	------------------------	----------------------

Note:

The scan may automatically go from the RUN state to the STOP state when the CYCLE-COUNT is reached.

STATUS	softkeys ACTIVATE or SUPP (see "Symbols" on page 11)	
MEM	memory location number (select by spinwheel or enter by MEM key)	

Note:

*The parameters FRQ, MOD, BW, SQ, ATT, ANT and AFC are directly displayed parameters and cannot be directly edited in the memory location. They can only be modified by exchanging the contents of the current memory location with the data of the receiver by the **RX <->MEM** key and then editing them and exchanging them back again.*

3.18.1.2 M-SCAN - CONFIG - DELETE

This menu can be obtained by pressing the DELETE softkey in the M-SCAN - CONFIG menu. A window with commands for deleting memory location contents opens.

120 KHZ	FM	MGC OFF	SQU 48	TONE OFF	CYCLES
OFF	MEM: FRQ 1 234.567 000		1 234.567 000		
AFC	MOD FM		SQ FROM MEM: ON		
AVG	BW 120 KHZ		DELETE MEMORY CONTENTS		
999	SQ 48 ATT-OFF				
	ANT 0 AFC-OFF				
RUN -	RUN +	ACTIVATE	ALL	CURRENT	ESCAPE

Softkeys

- ALL** Delete all
- CURRENT** Delete current memory location (select with the MEM key, then choose the memory location with the spinwheel)
- ESCAPE** Nothing is deleted, window is closed

3.18.2 F-SCAN

In the operation mode F-SCAN a frequency range which is defined with start frequency and stop frequency is monitored during scanning. To the current frequency the step frequency is added or subtracted and the resulting frequency set. For every set frequency the level is measured. On the occupied channels, that is, channels with a signal bigger than the set squelch threshold, the scanning stops for a definable time. The effective squelch threshold can be tuned with the squelch potentiometer. The IF bandwidth should be at least as large as the selected step width.

This menu can be obtained by pressing the F-SCAN softkey in the MAIN menu. The MAIN menu contains frequency scan menus.

150 KHZ	FM	MGC OFF	SQU 40	TONE OFF	FRQ
OFF	←	20.000 MHz	1 234.567 000		
AFC	→	650.000 MHz			
PEAK	↔	10.000 KHZ	0 20 40 60 80	**	
999□	T_DWELL:	0.5 S	49.2 dBµV		F-SCAN
RUN -	RUN +	STOP	SUPP	CONFIG	

Displayed parameters

←	Start frequency:	9 kHz to 3 GHz
→	Stop frequency:	9 kHz to 3 GHz
←→	Step frequency:	1 Hz to 10 MHz
T_DWELL	Dwell time:	0.0 to 10.0 sec / infinite
T_NOSIG	Signal-controlled scan after pause:	OFF/ 0.0 to 10.0 sec

Softkeys

RUN-	Scan starts from current frequency or from stop frequency, decreasing frequency
RUN+	Scan starts from current frequency or from start frequency, increasing frequency

Note:

When the current RUN key is in inverse video, this indicates that an F-SCAN is being performed. If the RUN key is pressed and it is in inverse for only a short time then the complete scan range is suppressed.

STOP	Stops the scan
SUPP	The SUPP function suppresses a frequency range. This frequency range is derived from the current frequency +/- ½ bandwidth. Up to 100 frequency ranges can be stored and edited in the menu F-SCAN CONFIG SUPP.
CONFIG	Goes to the F-SCAN CONFIG configuration menu

Note:

The scan may automatically go from the RUN state to the STOP state when the CYCLE-COUNT is reached.

3.18.2.1 F-SCAN - CONFIG

This menu is obtained by pressing the CONFIG softkey in the F-SCAN menu.

120 KHZ	FM	MGC OFF	SQU 48	TONE OFF	F-STOP
OFF	←	1 234.567 MHz			1 234.567 000
AFC	→	1 423.567 MHz			
AVG	↔	10.000 KHZ	T_DWELL: 2.0S		F-SCAN
999			T_NOSIG: OFF		CONFIG
			CYCLES: 1		
RUN -	RUN +				SUPP

Softkeys

- RUN-** Scan starts from the current frequency or the stop frequency with decreasing frequency. There is a menu change after F-SCAN
- RUN+** Scan starts from the current frequency or the start frequency with increasing frequency. There is a menu change after F-SCAN
- SUPP** Goes to the F-SCAN CONFIG SUPP configuration menu

Configuration of the scan range parameters

Select F-scan range

- |← Start frequency: 10 kHz to 3 GHz
- >| Stop frequency: 10 kHz to 3 GHz
- <-> Step frequency: 1 Hz to 10 MHz

Configuration of the scan-run parameters

- T_DWELL** Dwell time: 0.0 to 10.0 sec /infinity
- T_NOSIG** Continues under signal control after pause: OFF/ 0.0 to 10.0 sec
- CYCLES** Number of scan cycles: 1 to 1000 / infinity

Note:

The scan may automatically go from the RUN state to the STOP state when the CYCLE-COUNT is reached.

3.18.2.2 F-SCAN - CONFIG - SUPP

This menu is obtained by pressing the SUPP softkey in the F-SCAN-CONFIG menu.

Only one line of the table with the suppressed frequency range is ever edited.

120 KHZ	FM	MGC OFF	SQU 48	TONE OFF	INDEX
OFF	INDEX	F-START	F-STOP		
AFC	07	1 634.567 000	1 634.568 000		
AVG	SUPPRESSED FREQUENCY RANGES 100				F-SCAN CONFIG
999					SUPP
SORT		DELETE	DEL ALL		

Configuration parameters

- INDEX** Current line number of the suppress table: 0 to 99
- F-START** Start frequency of the suppressed range
- F-STOP** Stop frequency of the suppressed range

Displayed parameters

- SUPPRESSED FREQUENCY RANGES** Current number of suppressed frequency ranges: 0 to 100
The number can be optimized by the SORT function.

Softkeys

- SORT** Sorts the suppressed frequency ranges in order of increasing frequency and, as appropriate, combines ranges that are contiguous
- DELETE** Deletes the current line in the table
- DEL ALL** Deletes the whole table

This menu is obtained by pressing the DEL ALL softkey.

120 KHZ	FM	MGC OFF	SQU 48	TONE OFF	INDEX
OFF	INDEX	F-START	F-STOP		
AFC	07	1 634.567 000	1 634.568 000		
AVG	SUI	DELETE THE WHOLE TABLE			
999	• ARE YOU SURE?		YES	NO	

Softkeys

- YES** The whole table will be deleted.
- NO** Abort

3.18.3 D-SCAN (option)

This menu is obtained by pressing the D-SCAN softkey in the MAIN menu.

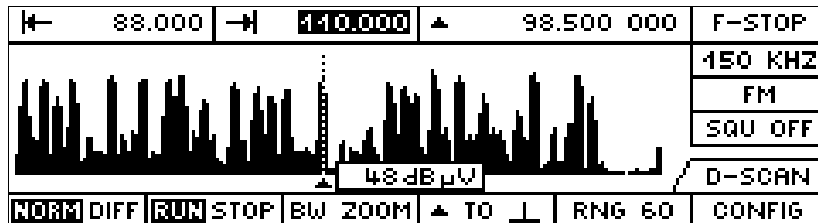

The marker position is highlighted through a dashed line. To the right next to the marker, the level measured at the marker position is represented in a tracking window. Thus individual signals can be measured for level and frequency.

Softkeys

The softkeys display the current corresponding status.

- NORM DIFF** toggle key: differential or normal spectrum
- RUN STOP** toggle key: sweep mode: listening mode (frozen spectrum)
- BW ZOOM** toggle key: change-over to bandwidth-zoom mode
- ^ TO ⊥** start action: marker to peak

The frequency marker jumps over to the next relative level maximum that is to the right of the marker in the DSCAN spectrum at SQU OFF. If the squelch function is switched on, the frequency marker is set to the next level maximum on the right above the squelch line. If no further level maximum is available on the right of the current level maximum, the frequency marker jumps over to the first level maximum on the left in the DSCAN spectrum.

- RNG 60** 4-way toggle key: Y-scaling (20, 40, 60, 80 dB span)
- CONFIG** Switch over to the configuration menu D-SCAN CONFIG

Symbols

- ^** Marker or receiver frequency
- |<** Start frequency
- >|** Stop frequency
- <->** Span frequency range (= stop frequency - start frequency)
- >|<** Center frequency (= stop frequency + start frequency / 2)

Note:

Due to system conditions the sweep width of 9 to 200 kHz for IF filter bandwidth 15 to 150 kHz cannot be used. The sweep width of 9 to 60 kHz for IF filter bandwidth <15 kHz cannot be used..

3.18.3.1 D-SCAN CONFIG

This menu is obtained by pressing the CONFIG softkey in the D-SCAN menu.

150 KHZ	FM	MGC OFF	SQU OFF	TONE OFF	MTIME
OFF	MEASURE TIME: DEFAULT				
AFC	D-SCAN SPEED: NORMAL				
PEAK	CYCLES: ∞				
999	REF LEVEL: 60 dBµV				D-SCAN
	DISPLAY LIMITS: 0 ... 60 dB				CONFIG
NORM DIFF	MAX	CLRWRITE		RNG 60	← → ▲

Softkeys

Each softkey shows the currently active state

- NORM DIFF** Toggle key: Normal or differential display of the spectrum
- MAX** In the spectrum the peak values are represented
- CLRWRITE** In the spectrum the current values are represented
- RNG 60** 4-way toggle key: Y-scaling (20, 40, 60, 80 dB display range)
- |< > ^** Toggle key: Parameter selection, start-, stop-, marker frequency or
- <-> ->|<- ^** span, center, marker frequency

Configuration of D-SCAN parameters

- MEASURE TIME** Measuring time: **DEFAULT / 0.5 msec to 900 sec**
 MEASURE TIME is valid globally for all measuring functions and can also be set in some other CONFIG menus. In some cases the name is shortened from lack of space with MTIME.
- D-SCAN SPEED** Scan speed: **MTIME PER CHANNEL /LOW / NORMAL / HIGH**

In the position **MTIME PER CHANNEL** the hardware supported sweep mechanism of the DSCAN is not used, but a step-by-step incrementing of the frequency as in the F-SCAN. That way it is possible to carry out the level measurement with a defined measuring time for each channel. This operation mode is suitable for the measurement of impulsive noises with simultaneous representation of the spectrum on the display of the EB200.

The digital scan can not be stopped in his procedure. Therefore the generated data can disappear, if they are not picked up fast enough at the remote control interface. The maximum data quantity at the remote control interface can be determined indirectly by setting the DSCAN speed.

The position **NORMAL** corresponds to an average speed with which under good preconditions all resulting data can be passed on through the Ethernet interface by means of TCP to an application. This is the default setting after the switch-on of the EB200 and corresponds to the DSCAN speed corresponding to the firmware versions up to V01.07.

The position **LOW** corresponds to a speed, that is for instance around the factor 10 smaller than in the position **NORMAL**. The maximum data quantity limit is around 6 Kbyte/s. With this setting it is possible to transfer all data via the RS232 PPP interface by means of UDP.

The position **HIGH** corresponds to the maximum speed. The data quantity can amount up to 320 Kbyte/s. The resulting data can be transmitted then only through the Ethernet interface and by means of UDP to an application.

CYCLES	Number of sweeps	1 to 1000 / infinite
REF LEVEL	The reference level determines the largest level value to be represented. It can be set in the range of 0 to 110 dB μ V in steps of 10 dB. Also intermediate values can be set via remote control or by means of direct number input.	
DISPLAY LIMITS	Display range of the spectrum:	eg -20 dB μ V to 60 dB μ V

Initially the upper value of the DISPLAY limits is firmly linked to the reference level.

If, however, the SW option EB200FS (Field Strength Measurement) is fitted, the upper value of the DISPLAY LIMITS can be configured independent of the reference level. In this case it can be varied in the range from 0 to 250 dB in 10-dB increments. Shifting the display range to values near 250 dB is only necessary if very high antenna k-factors are to be taken into account.

The lower value is calculated from the upper value of the DISPLAY limits minus the current RNG.

Note:

In D-SCAN the measuring time is only important when it comes to setting the D-SCAN SPEED to MTIME PER CHANNEL. In this case frequency scanning will in fact be performed, the results being shown in a spectrum. A measuring time other than the DEFAULT can only be adjusted with IF sections that are fitted with the DDC2 (see also "SYSTEM menu" on page 40).

3.18.3.2 D-SCAN cycle

When D-SCAN (digital scanning) is running (RUN is shown in inverse video), the synthesizer is being tuned to the exact frequency of the channels. Channel spacing always equals half the IF bandwidth. The level of each channel is being measured. The displayed spectrum is derived from the sum of the measured levels

The number of channels is derived from the span frequency divided by half the IF bandwidth. The higher the number of channels is, the longer takes the D-SCAN cycle.

3.18.3.3 Spectrum display NORM (normal)

The display always shows a spectrum of 190 level lines according to its pixel resolution and it does not depend on the number of channels. If the number of channel exceeds 190, the measured values of several channels will be combined in a way that the respective highest level will be displayed. The frequency of the channel with the highest level will be stored in the background so that the correct frequency can be set for the marker-to-peak process.

However, through the remote control interface, all measured channels are always output. In this case the representation reduced to 190 lines is not available.

If the number of channels is smaller than 190, several level lines will get the same length from which a spectrum of rough steps is derived.

The level is indicated by 35 pixels in the y-axis. The resolution can be set in four steps by the **RNG** softkey. In order to avoid overdriving of the receiver, the reference level is set to the highest expected positive signal level. Every desired reference level can be set via remote control by command `VOLTagE:AC:RANGe` in the range of 0 to 110 dB μ V.

3.18.3.4 Spectrum display NORM with squelch on

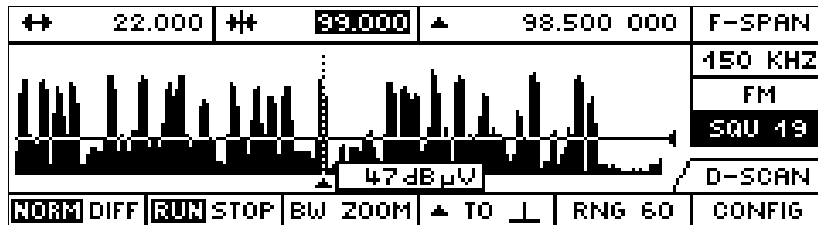

When the squelch is set on, the squelch line is displayed at a y-position corresponding to the squelch value. Furthermore the function of the marker-to-peak softkey is extended so that every time the softkey is pressed, the mark jumps to the next signal maximum above the squelch line, one after another.

3.18.3.5 Spectrum display in STOP mode

If a spectrum was generated and displayed in the RUN mode and STOP is pressed then the current spectrum will be frozen. The receiver sets the mark frequency. By pressing marker-to-peak softkey there will be a jump to the next signal maximum which can be listened to.

3.18.3.6 Spectrum display DIFF (differential mode)

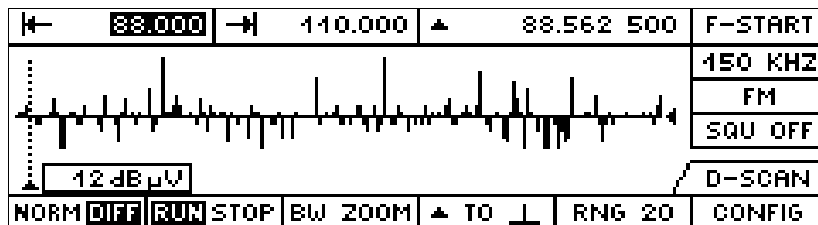

Every time being in the RUN mode when there will be a change-over from NORM to DIFF, the last spectrum will be internally stored as a reference spectrum and the differential display will be set on. For this spectrum the last stored reference spectrum will be subtracted from the current one and the resulting level lines will be displayed with correct signs. Thus new signals will be displayed as positive and missing signals as negative level lines. The y-scaling is set to $\pm \frac{1}{2}$ of the RNG value regardless of the RNG softkey setting. With squelch off, the marker-to-peak softkey lets the marker frequency jump to the absolute level maximum. With squelch on, the marker frequency will jump to the next level maximum with a positive deflection above 5 dB.

3.18.3.7 Spectrum display with BW ZOOM

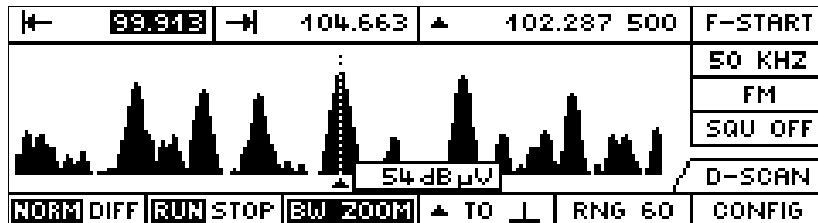

For a more accurate analysis of single signals the **BW ZOOM** can be set on. In this mode there is a firm rule that one pixel on the y-axis equals one channel and thus the frequency range of half the IF bandwidth. When the **BW ZOOM** is set on, the frequency mark is set to the display center and from there a new frequency span is built corresponding with above rule. If the IF bandwidth will be changed now the frequency span will be carried along correspondingly. The old span and center frequency and IF bandwidth are stored when the **BW ZOOM** is set on and when it is set off they are restored.

3.18.4 RX-CONF (receiver configuration)

This menu is obtained by pressing the RX-CONF softkey in the MAIN menu.

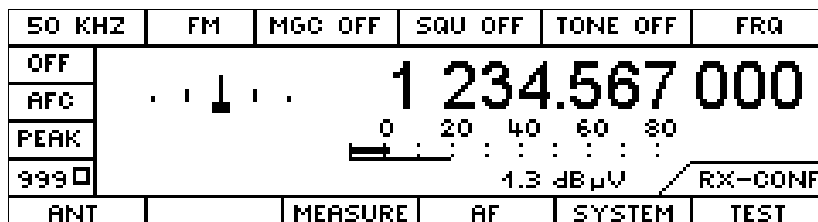

Softkeys

- ANT** Branch into the menu for antenna number parameters
- ATT** Branch into the menu for attenuator parameters
- MEASURE** Branch into the menu for measuring time parameters
- AF** Branch into the menu for **A**udio **F**requency parameters
- SYSTEM** Branch into the menu for software versions and software releases
- TEST** Branch into the menu for built-in test

3.18.4.1 ANT (antenna)

This menu is obtained by pressing the ANT softkey in the RX-CONF menu.

120 KHZ	AM	MGC OFF	SQU OFF	TONE OFF	NUMBER
OFF	ANTENNA NUMBER: 1				
AFC	ANTENNA CODE: HE200				
FAST	AUX OUTPUT: ANT + CTRL				RX-CONF
999					ANT

Antenna control via AUX port X8 using 2-digit BCD. The AUX port X8 is the connector with the name X8 at the rear panel of the EB200. For the pin assignment please see interface description in the annex.

Displayed parameters

ANTENNA NUMBER: Antenna number from 0 to 99

ANTENNA CODE: 5-digit antenna code

If the parameter **ANTENNA CODE** is selected one character at a time can be selected with the softkeys <- or -> and it can be varied with the spinwheel.

AUX OUTPUT: FREQ or ANT + CTRL (selection by spinwheel).

At the rear panel of the EB200 on the two 8-bit ports can either the frequency information in BCD four-digit (1 MHz, 10 MHz, 100 MHz and 1 GHz) or the antenna number with two digits on the one port and the CTRL byte in binary form on the other port be output. (see also AUX on page 55).

Softkeys

The following two softkeys appear only with installed software option EB200FS (Field Strength).

ANT PAS K-factor table for passive antennae (eg HE200 without amplifier)

ANT AKT K-factor table for active antennae (eg HE200 with amplifier)

3.18.4.2 MEASURE (configuration of measuring time parameters)

(See also Annex E (Measuring Functions))

150 KHZ	FM	MGC OFF	SQU OFF	TONE OFF	MTIME
OFF	MEASURE TIME: DEFAULT				
AFC	IF-PAN MODE: CLRWRITE				
PEAK					RX-CONF
999 □					MEASURE
CONTIN	PERIODIC				

Softkeys

The softkeys indicate in each case the active state inversely.

CONTIN continuous measurement of all values

PERIODIC periodic measurement of all values with measuring time

Configuration of the MEASURE parameter

MEASURE TIME: Measuring time: DEFAULT / 0.5 msec to 900 sec

The TIME MEASURE applies globally to all measuring functions and can also be set in some other CONFIG menus. In part the name is shortened from lack of space with MTIME.

Note:

A measuring time other than the DEFAULT can only be adjusted with IF sections that are fitted with the DDC2 (see also "SYSTEM menu" on page 40).

IF-PAN MODE: Level evaluation in the spectrum of the IF panorama: MIN, MAX, AVG, CLRWRITE

3.18.4.3 AF configuration

This menu can be obtained by pressing the AF softkey in the RX-CONF menu.

120 KHZ	FM	MGC OFF	SQU 48	TONE OFF	TONE
OFF	SPEAKER: ON				
AFC	TONE: ONLY				
AVG	BALANCE: L . . ↓ . . R		RX-CONF		
999□			AF		

Configuration of the AF (Audio Frequency) parameters

AF parameters and signal paths

SPEAKER: Speaker status OFF, ON

This switch works only for the built-in loudspeaker. The AF is always available at the headphone socket.

TONE: ONLY, WITH AF

In the position TONE WITH AF, the audio frequency is audible additionally to the signal tone.

BALANCE: Between left and right audio channel at the headphone connector

The bar can be shifted to the left or to the right by spinwheel. The EB200 is not equipped for stereo reception.

3.18.4.4 SYSTEM menu

This menu is obtained by pressing the SYSTEM softkey in the RX-CONF menu.

120 KHZ	FM	MGC OFF	SQU OFF	TONE OFF	FRQ
AUTO	MAIN	CPU	V02.50	2001-01-25	SOFTWARE
AFC	IF	DSP	V03.23	2001-01-16	
AVG	IF PAN	DSP	V01.03	2000-08-10	
346	FP CTRL	CPU	V01.02	1998-12-09	RX-CONF
	DC-CONVERTER	CPU	V01.08		
	SERIAL NUMBER:	EB200	837.765/001		SYSTEM
	PROTECT	SW OPT	RESET		

Display of software version and series number

MAIN CPU	Main controller
IF DSP	DSP for the IF-section
IF PAN DSP	DSP for IF-panorama (option)
FP CTRL	Keyboard controller
DC-CONVERTER CPU	Controller for DC/DC converter
SERIAL NUMBER	Receiver serial number

Note:

From MAIN CPU version 2.31 onwards, the configuration of the IF section can be determined from the version of the DSP software (IF DSP).

If the version is shown to be less than V03.00, the IF section is equipped with DDC1.

If the version is shown to be greater than V03.00, the IF section is equipped with DDC2.

Configuration with DDC2 is the precondition for future software options such as EB200CM and the configuration of a measuring time. For IF sections with DDC2 no offset measurement is possible in the CW, USB, LSB and IQ modes.

Softkeys

RESET	Reset to the Rohde & Schwarz default settings. The same function is triggered via remote control by the command *RST.
PROTECT	Branches to the password entry menu
SW OPT	Branches to the menu for SW options

PROTECT password entry

This menu is obtained by pressing the PROTECT softkey in the SYSTEM menu.

120 KHZ	FM	MGC OFF	SQU 48	TONE OFF	LOCK
OFF	PASSWORD STATUS: OFF				
AFC					RX-CONF
AVG					SYSTEM
999 □					PROTECT
	EDIT PW	DEL PW			

If the password status is ON, the user is asked to enter the password when the unit is turned on.

Display parameter

PASSWORD STATUS ON, OFF

Softkeys

EDIT PW Branches to the password entry menu

120 KHZ	FM	MGC OFF	SQU 48	TONE OFF	FRQ
OFF	ENTER NEW PASSWORD: <input type="text"/>				
AFC	ENTER A VALUE BETWEEN				RX-CONF
AVG	100 AND 99999999				SYSTEM
999 □					PROTECT
	EDIT PW	DEL PW			

DEL PW Branches to the menu for deleting the password. The display of this menu is similar to the one for entering a password.

SW OPT software options

This menu is obtained by pressing the SW OPT softkey in the SYSTEM menu.

120 KHZ	FM	MGC OFF	SQU OFF	TONE OFF	FRQ
AUTO	DIGI SCAN OPTION: INSTALLED				RX-CONF SYSTEM SW OPT
AFC	COVERAGE MEASUREMENT: NOT INSTALLED				
AVG	FIELD STRENGTH: NOT INSTALLED				
0					
		INSTALL			

Display parameter:

Status display, activated SW options

DIGI SCAN OPTION: Quick sweep function with spectrum display and remote-controlled output of all measured values

COVERAGE MEASUREMENT: Fast externally or internally triggered level measurement on a frequency or on a frequency list This option can be used only via remote control. See also Annex G (Coverage Measurement).

FIELD STRENGTH: With this option it is possible to carry out field strength measurements. Additionally to the level indication in dBµV the field strength is indicated in dBµV/m. For the calculation of the antenna correction factors the K-factors of the Rohde & Schwarz antennae HE200 and HE200HF as well as a generic dipole are permanently stored. Self-defined K-factor data can be loaded into the EB200 via remote control. See also Annex H (Field Strength Measurement).

Softkey

INSTALL Branches to the SW_OPT menu

Activating a SW option by entering an 8-digit code number

120 KHZ	FM	MGC OFF	SQU 48	TONE OFF	FRQ
OFF	SC	ENTER OPTION-CODE: 12345678			RX-CONF SYSTEM SW OPT
AFC	SC	AND RESTART YOUR SYSTEM TO ACTIVATE THE NEW SOFTWARE OPTION!			
AVG	SC				
999					
		INSTALL			

Note:

When ordering a software option at a later stage the serial number of the EB200 is to be indicated.

3.18.4.5 TEST

This menu is obtained by pressing the TEST softkey in the RX-CONF menu

120 KHZ	AM	MGC OFF	SQU OFF	TONE OFF	POINT
OFF	TEST POINT: OFF		MIN:	MAX:	
AFC	PRESELECTION:	OK	FRONT PANEL:	OK	
FAST	FRONTEND:	OK	REMOTE LAN:	OK	
999	IF SECTION.2:	OK	IF PANORAMA:	OK	RX-CONF
	PROC / ERAM:	OK	DC CONVERTER:	OK	TEST
LONGTEST					

Note:

If the processor is equipped with the expansion RAM, PROC/ERAM instead of PROCESSOR is displayed.

If the EB 200 is equipped with a new IF section (produced as from 4. 2000), IF SECTION.2 appears on the display. This IF section has an extended dynamic range. Level measurements can be made up to

85 dBµV (with ATT ON 113 dBµV) without overdrive. If overdrive occurs, the symbol  is displayed. With the new IF section, the 30 dB attenuator cuts in at the overdrive limit of 85 dBµV and switches off with a hysteresis of 7 dB.

Softkey

LONGTEST Starts a complete unit testing procedure

At the LONGTEST all test spectrum lines are scanned. At first two runs with attenuator and the bandwidth 150 kHz and/or 15 kHz are carried out. With that the preselection is bypassed first and feeding-in takes place directly at the Frontend. If both of the runs supply an error-free result, a third run with disconnected attenuator is carried out. If also this run does not supply any errors, a short test is carried out with the current receive frequency.

As a result the OK message "TEST OK , RF RANGE AND SIGNAL PATHES" or an error report is output. The error reports are determined as follows:

1. or. 2. test run reports errors:

If all measuring frequencies report errors the message "SENSITIVITY OUT OF RANGE" is generated. Otherwise it is checked whether all measurement points produce errors at a specific bandwidth. In this case the message "IF PREFILTER WIDE DEFECTIVE" or "IF PREFILTER NARROW DEFECTIVE" is generated.

If the error fits into neither category a list with up to 4 faulty frequencies and an error message like eg "LEVEL TOO HIGH AT 128 MHZ" is output.

1st and 2nd test runs do not report any error, 3rd test run reports error:

If all measuring frequencies report errors the message "SENSITIVITY OUT OF RANGE" is generated. Otherwise error messages for those preselection ranges are generated in the frequency range of which faulty measuring points are located.

Configuration parameters

TEST POINT OFF or selection of a test point of the subassemblies. When a test point is selected, a permanent display windows opens.

The window contains the name of the subassembly, the selected test point, the current voltage in mV and, if necessary, an arrow that indicates whether is above or below the limit.

Display parameters

MIN: The permissible minimum test point voltage (in mV)

MAX: The permissible maximum test point voltage (in mV)

If no min. and max. values are displayed, this test point is not relevant for the current state of the unit.

50 KHZ	FM	MGC OFF	SQU OFF	TONE OFF	POINT
OFF	TEST POINT: TGAIN MIN: 1350 MAX: 1950				
AFC	F	PRESELECTOR	<	FRONT PANEL: OK	
PEAK	F	TGAIN	<	REMOTE LAN: OK	
999□	F	1579	<	IF PANORAMA: OK	RX-CONF
			<	DC CONVERTER: OK	TEST
LONGTEST					

The test-point window without minimum and maximum values can be displayed in every menu of the unit. This means that it is possible to observe a particular point in all the unit's operating states.

Menus in which the SEL key has no function and in which this key is pressed, a test point can be selected by spinwheel.

3.18.5 DISPLAY (display variants)

This menu is obtained by pressing the DISPLAY softkey in the MAIN menu.

150 KHZ	FM	MGC OFF	SQU OFF	TONE OFF	FRA
OFF					
AFC					
PEAK					
999 □					
5.8 dBµV		DISPLAY			
DEFAULT	IF-PAN	LEVEL	TONE	CONFIG	MORE

With this menu, you can select quickly from a number of display variants. This permits parameters important for a particular task to be put to the foreground.

Using the MORE softkey, further parallel selection modes can be chosen.

Each display variant has its own specific CONFIG menu.

The selected variant is maintained even if the MAIN menu or any other menu is called up. When the DEFAULT has been selected, in submenus M-SCAN and F-SCAN the display variant specific for these modes will be shown. With D-SCAN there are no variable display variants.

DEFAULT - CONFIG

This menu is obtained by pressing the CONFIG softkey in the DISPLAY menu

150 KHZ	FM	MGC OFF	SQU OFF	TONE OFF	MODE
OFF	DISPLAY MODE: INVERSE				DEFAULT CONFIG
AFC	ILLUMINATION: STEP 6				
PEAK	SWITCH OFF: NEVER				
999 □	TUNING AID: SYMBOLIC				
LOW BAR LIMIT: -10 dBµV					

Configuration parameters

- DISPLAY MODE:** INVERSE, NORMAL (this setting is global)
- ILLUMINATION:** Illumination of back lighting OFF / STEP1 ... STEP6
- SWITCH OFF:** Switch-off time of back lighting
NEVER, 0.5 MIN, 1 MIN, 2 MIN, 3 MIN, 5 MIN, 10 MIN, 20 MIN
- TUNING AID:** Display variations of frequency offset (see "Offset display, " on page 9)
NUMERIC, SYMBOLIC, IF PAN (option)
- LOW BAR LIMIT:** Setting of the lower end of scale
of the level bargraph at ATT OFF: -30 dBµV, -10 dBµV, 10 dBµV

DISPLAY DEFAULT with TUNING AID: IF PAN

This menu is obtained by configuring, in the Default Config Menu, the **LOW BAR LIMIT** to IF PAN.

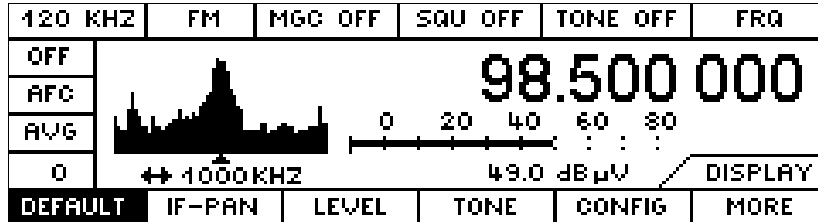

3.18.5.1 IF-PAN (IF panorama)

This menu is obtained by pressing the IF PAN softkey in the DISPLAY menu, provided the optional hardware EB200 SU (IF panorama) is installed.

150 KHZ	FM	MGC OFF	SQU OFF	TONE OFF	FRA	
OFF	REF 60	RNG 80	SPAN 1000KHZ	98.500 000		
AFC				MTIME DEFAULT		
PEAK				LEVEL		
999 □				50.6		DISPLAY
DEFAULT		IF-PAN	LEVEL	TONE	CONFIG	MORE

IF-PAN (IF panorama) - CONFIG

This menu is obtained by pressing the CONFIG softkey in the IF-PAN menu.

120 KHZ	FM	MGC OFF	SQU OFF	TONE OFF	REF	
AUTO	REF 90	RNG 80	SPAN 30KHZ	100.008 000		
AFC				MTIME DEFAULT		
AVG				LEVEL		IF-PAN
0				50.1		CONFIG
MIN	MAX	AVG	CLRWRITE	↓ TO ▲	↓ TO ▲	

Display parameter

LEVEL Level measured on receive frequency

Configuration parameters

REF The reference level sets the maximal level value that can be displayed. It can be set within a range of -20 to 120 dBµV in steps of 10 dB.

RNG The range value sets the range that can be displayed on the y-axis. It can be set within a range of 10 to 160 dBµV in steps of 10 dB.

SPAN The Span sets the width that can be displayed in the IF panorama in 17 steps within the range of 150 Hz to 1000 kHz. In the COUPLED mode the displayed width equals the width of the cut-in IF filter.

MTIME Measuring time: DEFAULT / 0.5 msec to 900 sec

Note:

A measuring time other than the DEFAULT can only be adjusted with IF sections that are fitted with the DDC2 (see also "SYSTEM menu" on page 40).

Softkeys

MIN	Starts the MIN-Hold process. Every time this key is pressed the MIN-Hold process is restarted.
MAX	Starts the MAX-Hold process. Every time this key is pressed the MAX-Hold process is restarted.
AVG	Starts averaging according to selection. Each time this key is pressed the averaging function AVG is started anew. The measured level values are averaged over the measuring time.
CLRWRITE	Activates the CLEAR WRITE function. The currently measured level values are displayed. Here the measuring time is of no importance.
└┘ TO ^	Centers the spectrum to the next relative level maximum left of the marker when the squelch is off. When it is on the center frequency is set to the next level maximum to the left which is above the squelch line.
┘└ TO ^	Centers the spectrum to the next relative level maximum right of the marker when the squelch is off. When it is on the center frequency is set to the next level maximum to the right which is above the squelch line.

With switched on squelch the squelch value is indicated as a horizontal line in the spectrum. Thus the level of the individual frequencies can be measured.

Note:

The level indication of the receiver is identical only in exceptions with the height of the average spectrum line (for example with a CW carrier). In the case of broad-band signals or noise, differences up to 20 dB and more occur. This is caused by the different bandwidth with which the level detection is carried out. The resolution bandwidth of the panorama equals approx. 1/1000 of the set span.

3.18.5.2 LEVEL BAR (level measurement)

This menu is obtained by pressing the LEVEL softkey in the DISPLAY menu.

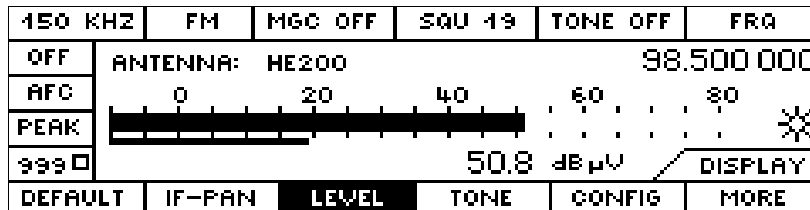

Just as the large level bar display, this window also shows the antenna which is currently activated, and the numerical level indication.

LEVEL (level measurement) - CONFIG

This menu is obtained by pressing the CONFIG softkey in the LEVEL menu.

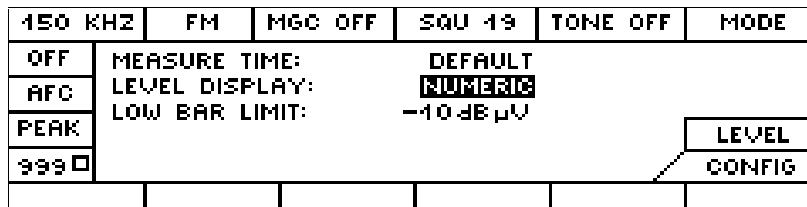

Configuration parameters

- MEASURE TIME:** Measuring time: DEFAULT / 0.5 msec to 900 sec
- LEVEL DISPLAY:** Level indication: BAR / NUMERIC
- LOW BAR LIMIT:** Setting of lower end of scale of level bargraph indication at ATT OFF: -30 dB μ V, -10 dB μ V, 10 dB μ V

Note:

A measuring time other than the DEFAULT can only be adjusted with IF sections that are fitted with the DDC2 (see also "SYSTEM menu" on page 40).

LEVEL NUMERIC

This menu is obtained by pressing the LEVEL softkey in the DISPLAY menu if in the LEVEL-CONFIG menu the parameter LEVEL DISPLAY has been set to NUMERIC.

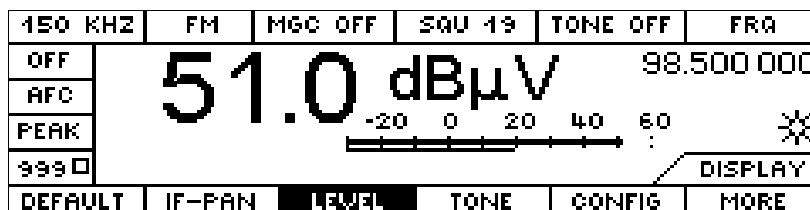

3.18.5.3 TONE (signal tone; pitch depends on the signal level)

The menu is obtained by pressing the TONE softkey in the DISPLAY menu.

120KHZ	FM	MGC 104	SQU 8	TONE 15	LOCKED
AUTO	15			460.515 151	
AFC	-1	3	7	11	19 23 27 31
PEAK	[Level bar]				☼
999□	22.0 dBμV			DISPLAY	
DEFAULT	IF-PAN	LEVEL	TONE	CONFIG	MORE

This menu shows the expanded level bar display (see "Level display" on page 8).

Starting from this value, the level scale is expanded into the range -15 to +15 dB and the level magnitude is represented by the pitch of a tone (0 dB corresponds to about 400 Hz).

When the MORE softkey is pressed, the following selection modes are available.

TONE - CONFIG

This menu is obtained by pressing the CONFIG softkey in the TONE menu.

150 KHZ	FM	MGC OFF	SQU 19	TONE OFF	MTIME
OFF	MEASURE TIME:		DEFAULT		
AFC	TONE:		ONLY		
PEAK					TONE
999□					CONFIG

MEASURE TIME: Measuring time: DEFAULT / 0.5 msec to 900 sec

TONE: Tone without/with audio frequency ONLY / WITH AF

Note:

A measuring time other than the DEFAULT can only be adjusted with IF sections that are fitted with the DDC2 (see also "SYSTEM menu" on page 40).

3.18.5.4 FRQ (frequency)

This menu is obtained by pressing the FRQ softkey in the DISPLAY-MORE menu.

150 KHZ	AM	MGC OFF	SQU -17	TONE OFF	FRQ
OFF	<div style="font-size: 2em; font-weight: bold;">100.000 000</div> <div style="font-size: 1.2em; font-weight: bold;">94.1 dBμV</div>				
AFC					
AVG					
0					
FREQ				CONFIG	MORE

Here the numerical level value is shown in addition to the large frequency display.

For reasons of space, the position of the overdrive indicator differs from that in the other menus. This symbol flashes to indicate that the IF section is overdriven. This indication will only appear with IF sections that in the RX-CONF – TEST menu are represented as IF SECTION.2.

3.18.6 SETUP

This menu is obtained by pressing the SETUP softkey in the MAIN menu.

120 KHZ	FM	MGC OFF	SQU OFF	TONE OFF	FRQ
AUTO	<div style="font-size: 2em; font-weight: bold;">98.500 000</div> <div style="font-size: 1.2em; font-weight: bold;">26.0 dBμV</div>				
AFC					
AVG					
0					
KEYS	MESSAGE	POWER	REF	AUX	REMOTE

3.18.6.1 KEYS

This menu is obtained by pressing the KEYS softkey in the SETUP menu.

120 KHZ	FM	MGC OFF	SQU 48	TONE OFF	LOCK
OFF	ROLLKEY: PROGRESSION:			STEP2	
AFC	INCR VALUE:			1.000 KHZ	
AVG	KEYS:	KEYCLICK:	SOUND1 QUIET	SETUP	
999	SAVE :	NEXT FREE		KEYS	

Configuration of the spinwheel functions and the key characteristics. The selection is made with SEL, the spinwheel and the editor (number block).

ROLLKEY configuration

PROGRESSION Progression factor of frequency setting by spinwheel
OFF, STEP1 to STEP9

INCR VALUE Any increment which is added to or subtracted from the receiving frequency if there is a rollkey pulse.
0.001 to 1000 kHz
For SSB modulation (CW, LSB and USB) an increment value of 1 Hz is always automatically set.

KEYS configuration

KEYCLICK Setting the key click
OFF, SOUND1 QUIET, SOUND1 LOUD, SOUND2 QUIET, SOUND2 LOUD, SOUND3 QUIET, SOUND3 LOUD,

SAVE KEY Determines the function of the SAVE key

CURRENT MEM The receiver parameters will be stored in the current memory location

CURRENT MEM + ACT Like CURRENT MEM, additionally the memory location will be set for an MSCAN query (ACTivate)

NEXT FREE The receiver parameters will be stored in the next free memory location

NEXT FREE + ACT Like NEXT FREE, additionally the memory location will be set for an MSCAN query

Configuring the SAVE key to NEXT FREE + ACT is very useful when it comes to save frequencies found with F-SCAN or D-SCAN to the memory with just one key stroke. These frequencies can then be further observed by using the M-SCAN.

3.18.6.2 MESSAGE

Configuration of the acoustic and optical messages to the operator.

This menu is obtained by pressing the MESSAGE softkey in the SETUP menu.

120 KHZ	FM	MGC OFF	SQU 48	TONE OFF	DISPLAY
OFF	MESSAGE DISPLAY:		DURATION 2 SEC		
AFC	MESSAGE BEEP:		LOUD		
AVG	USER WARNING:		ON		SETUP
999	COMPONENT FAILURE:		ON		MESSAGE

Error messages

- MESSAGE DISPLAY** OFF, display duration for error messages: 1, 2, 3, 4, 5 sec and infinite (see "**Status and error messages**" on page 12)
- MESSAGE BEEP** Setting the volume of the error beep
OFF, QUIET, LOUD
- USER WARNING** Setting the user warning on and off
ON, OFF
- COMPONENT FAILURE** Enabling or disabling messages of component errors
ON, OFF

3.18.6.3 POWER

This menu is used to display all parameters of the DC power supply which might be connected.

This menu is obtained by pressing the POWER softkey in the SETUP menu.

120 KHZ	FM	MGC OFF	SQU OFF	TONE OFF	FRA
AUTO	SOURCE: BATTERY PACK				
AFC	BATTERY1: IN USE 45 % CHARGED				
AVG	BATTERY2: NOT IN USE 48 % CHARGED				
0	TIME TO EMPTY: 165 MIN				POWER

Configuration parameters

SOURCE: Power source:
DC X1 DC power supply or charger
BATTERY PACK EB200 Battery Pack
DC X2 Battery belt

BATTERY1 / 2: Status of battery 1 / 2:
NOT EQUIPPED
NOT IN USE
IN USE
CHARGING

TIME TO EMPTY: Display of remaining service time in minutes (overall service time of batteries 1 and 2)
 The display is only active for supply from the battery pack.

When the remaining service time has come down to 10 min, the warning "BATTERY EMPTY IN LESS THAN 10 MINUTES" comes up in a cyclic fashion.

3.18.6.4 REF

Selection of the reference signal

This menu is obtained by pressing the REF softkey in the SETUP menu.

120 KHZ	FM	MGC OFF	SQU 48	TONE OFF	REF
OFF	REFERENCE: INTERNAL				
AFC					
AVG					
999					REF

Configuration parameter

REFERENCE: Selection of reference frequency source
 INTERNAL, EXTERNAL

3.18.6.5 AUX

Configuration of the AUX-port parameters

This menu is obtained by pressing the AUX softkey in the SETUP menu.

120 KHZ	FM	MGC OFF	SQU OFF	TONE OFF	CTRL
OFF	CTRL: <input checked="" type="checkbox"/>				
AFC	OUTPUT: ANT + CTRL				
AVG					SETUP
999					AUX

Configuration parameters

CTRL: Setting the AUX bits of socket X8 (rear panel)
0 to 255

OUTPUT: FREQ or ANT+CTRL

The two rear-panel 8-bit ports can be used to output the frequency information in four-digit BCD (1 MHz, 10 MHz, 100 MHz and 1 GHz) or the two-digit antenna number at one port and the binary CTRL byte at the other.

The connector X8 is located at the rear panel of EB200. For its pin assignment refer to the interface description contained in the manual.

3.18.6.6 REMOTE (remote control)

Configuration of the remote-control parameters

This menu is obtained by pressing the REMOTE softkey in the SETUP menu.

One of the two options below can be fitted:

- RS232C control interface
- LAN control interface

The appropriate window for the fitted option opens automatically.

After a cold start, the Rohde & Schwarz default values are always used.

LAN control interface (option)

150 KHZ	FM	MGC OFF	SQU -10	TONE OFF	ADDR3
OFF	ADDRESS: 089.010.011.023		LAN		
AFC	PORT: 5555				
FAST	SUBNETMASK: 255.000.000.000				
999	GATEWAY: 089.010.015.070		SETUP		
				REMOTE	
				APPLY	

Configuration parameters

IP ADDRESS: Network ident of EB200

PORT: Remote control port

SUBNETMASK: Mask for a subnet

GATEWAY: Network indent of a router

Softkey

APPLY: Branching to subsequent submenu

APPLY CHANGES

Some parameters can be made active only by switching the unit off and on again. After confirmation the changes to such parameters with the YES key, the following warning is output: POWER DOWN REQUIRED FOR NEW SETTINGS.

150 KHZ	FM	MGC OFF	SQU -10	TONE OFF	ADDR3
OFF	ADDRESS: 089.010.011.023		LAN		
AFC	PORT: 5555				
FAST	SUBNETMASK: 255.000.000.000				
999	GATEWAY: 089.010.015.070		APPLY CHANGES?		
				YES	NO

YES: The changes are accepted. For some parameters the unit must be switched off and on again.

NO: The changes are discarded.

RS 232 control interface

If the unit is equipped with the RS232 control interface, a choice can be made between the modes RS232 PPP and RS232 standard. See also Appendix A.

RS 232 PPP

In this operating mode, TCP/IP with the **P**oint to **P**oint **P**rotocol is activated for remote control.

120 KHZ	FM	MGC OFF	SQU OFF	TONE OFF	BAUD
AUTO	BAUDRATE:	115.2 K			RS 232 PPP
AFC	IP-ADDRESS:	192.000.000.002			
AVG	PORT:	5555			
999				SETUP	
				REMOTE	
STANDARD	PPP				APPLY

Configuration parameters

- BAUD RATE:** Baud rate: 50 to 115 k with many intermediate values
- IP ADDRESS:** Network ident of EB200
- PORT:** Remote control port

Softkeys

- APPLY** Branching to APPLY CHANGES submenu
- STANDARD** Switchover to RS232 standard

RS 232 standard

120 KHZ	FM	MGC OFF	SQU OFF	TONE OFF	BAUD
AUTO	BAUDRATE: 115.2 K		RS 232		
AFC	FRAME: 7 BIT	1 STOP			
AVG	PARITY: NO				
999	HANDSHAKE: XON-XOFF		SETUP		
STANDARD		PPP	REMOTE		
			APPLY		

Configuration parameters

- BAUD RATE:** Baud rate: 50 to 115 k with many intermediate values
- FRAME:** 7 or 8 data bits, 1 or 2 stop bits
- PARITY:** NO, ODD or EVEN
- HANDSHAKE:** NO, XON-XOFF or RTS-CTS

Softkeys

- APPLY** Branching to APPLY CHANGES submenu
- PPP** Switchover to RS232 PPP

APPLY CHANGES

Some parameters can be made active only by switching the unit off and on again. After confirmation the changes to such parameters with the YES key, the following warning is output: POWER DOWN REQUIRED FOR NEW SETTINGS.

120 KHZ	FM	MGC OFF	SQU OFF	TONE OFF	BAUD
AUTO	BAUDRATE: 115.2 K		RS 232 PPP		
AFC	IP-ADDRESS: 192.000.000.002				
AVG	PORT: PPP				
999	! APPLY CHANGES? *				YES
STANDARD					NO

- YES:** The changes are accepted. For some parameters the unit must be switched off and on again.
- NO:** The changes are discarded.

Inhibiting the operating elements at remote control

The message in the softkey area of the display is switched on and off by the remote control command `SYSTEM:KLOCK ON|OFF`. At the same time the keyboard and the spinwheel are disabled. Now only pure remote-control operation is possible.

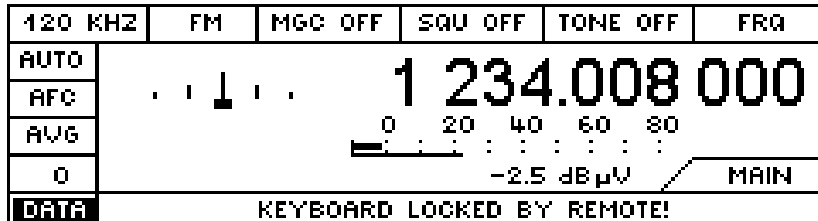

In this mode, a DATA lamp comes on in the text window.

The test in the message window can be specified by REMOTE with a special command. The Rohde & Schwarz default text is: KEYBOARD CONTROLLED BY REMOTE.

Inhibiting the display and operating elements at remote control

The display can be switched on and off by the remote-control command `DISPlay:ENABLe ON|OFF`. In this case, the entire front panel editing is disabled, providing additional processor capacity for remote control and hardware control.

RECEIVER MODE:	Indicates the current mode of the unit set via remote-control command <code>FREQuency:MODE</code> .
CW	Receiver monitors a frequency.
SWEEP	Receiver is in frequency sweep mode.
MSCAN	Receiver is in memory scan.
DSCAN	Receiver is in Digiscan mode.
FASTLEVCW	Receiver is in mode for fast triggered level measurement.
LIST	Receiver is in mode for fast level measurement in a frequency list.

The DSCAN mode can only be switched on if the SW option EB200DS (Digiscan) is fitted.

The FASTLEVCW and LIST modes can only be switched on if the SW option EB200CM (Coverage Measurement) is fitted.

The text in the 2nd line of the message window can be pre-defined by using the remote-control command `DISPlay:ENABLe:LABel „String with max 24 chars“`. The text pre-defined by Rohde & Schwarz is "CONTROLLED BY REMOTE".

The 3rd line shows the essential parameters of the remote-control interface:

Remote-control option: LAN

```

RECEIVER MODE  CW
                CONTROLLED BY REMOTE
                LAN  ADDRESS:  089 .010 .031 .016
    
```

LAN ADDRESS: Network ident of EB200

Remote-control option: RS232 in PPP mode

```

RECEIVER MODE  CW
                CONTROLLED BY REMOTE
                RS 232 PPP: 115.2 K,  ADDRESS: 192 .000 .000 .002
    
```

RS232 PPP: Baud rate: 50 to 115 k with many intermediate values

ADDRESS: Network ident of EB200

Remote-control option: RS232 in STANDARD mode

```

RECEIVER MODE  CW
                CONTROLLED BY REMOTE
                RS 232: 115.2 K,N,7,1
    
```

RS232: Baud rate, parity, data bits, stop bits

4 Remote control

4.1 Introduction

The device is equipped as standard with an RS232 interface. The 9-pin connector X9 is located at the rear of the device. The TCP/IP protocol with PPP is applied to this interface. From firmware version 2.31 onwards, this interface can also be configured for the RS232 standard (see menu SETUP:REMOTE and Appendix A).

The device can be equipped optionally with a LAN interface EB200 R4. The 8-pin RJ45 connector X91 is located at the rear of the device. The TCP/IP protocol is run on this 10 MBIT Ethernet interface.

The device supports the SCPI command syntax of version 1993.0 (Standard Commands for Programmable Devices). The SCPI standard is based on IEEE 488.2 and is aimed at standardizing device-specific commands, error handling and status registers (see "Notation" on page 13).

This section assumes basic knowledge of programming and operation of the controller. A description of the interface commands is to be obtained from the relevant manuals.

The requirements of the SCPI standard for command syntax, error handling and configuration of the status registers are explained in the relevant sections. Tables provide a fast overview of the commands implemented in the device and the bit assignment in the status registers. The tables are supplemented by a comprehensive description of every command and the status registers. Detailed programming examples of the main functions are to be found in Annex D. Annex C contains a reference list for all unit functions in manual and remote control with all the relevant references to the manual.

4.2 Brief instructions

4.2.1 Remote control via RS232 interface

The default values of the interface parameters of the EB200 are configured by host name and IP-address, respectively.

192.0.0.2 and port: 5555

For more information see annex A, interfaces.

1. Connect the EB200 and the controller by using the modem bypass cable RS232 stipulated for WindowsNT.
2. The RAS service has to be installed on the controller.
3. The PPP-connection to the controller is set up by starting the EB200.PBK file.
4. The ping command is a simple way to check whether the controller is able to make connection to the EB200. Just enter the command "ping <IP-Address>" (eg "ping 192.0.0.2") in the DOS box.
5. Commands can be sent to and messages can be received from the EB200 by means of a Telnet application which is started and configured with the interface parameters of EB200.
6. To test the connection, *idn? can be entered, for example, to query the EB200 identification. The response string should then be displayed.

4.2.2 Remote control via LAN interface (option)

The default values of the interface parameters of the EB200 are configured by host name and IP-address, respectively.

89.10.11.23 and port: 5555

For more information see Annex A, interfaces.

1. Connect the EB200 and the controller by using an Ethernet cable with RJ45 connectors. For direction connection to a network adapter card use a cross-cable. If the EB200 is connected to a network either via a hub or directly, a 1-to-1 cable is required.
2. On the controller TCP/IP must be installed. The network adapter card must be set to half-duplex.
3. When the EB200 is operated within a network, it must be set to a network-compatible IP address. The network administrator will be able to provide further information on this. Also see Annex D.
4. The ping command can be used to easily check whether the controller is able to make connection to EB200. Just enter the command "ping <IP-Address>" (eg "ping 89.10.11.23") in the DOS box.
5. By using a Telnet application configured with the interface parameters of EB200 commands can be sent to and responses be received from EB200.
6. To test the connection, *idn? can be entered, for example, to query the EB200 identification.

Note:

If previously a connection had been made to another unit with the same IP address, it may be necessary to delete the corresponding entry in the ARP table by entering the command "ARP -d <IP address>" in the DOS box.

4.3 Configuring the remote control

The device can at the same time be operated via the front panel and the remote-control interface. This operation is called "competing control" and is characterized by the fact that both the local operator and a detached operator have full access to all device functions. Moreover, any operator setting can be monitored by the remote-control interface.

"Competing control" can be switched over in favour of remote control via the remote control command `System:Klock ON` (see Annex A). In this case, manual control is fully disabled and has to be enabled by the remote-control `System:Klock OFF`.

4.3.1 Setting the IP-A and port number

If EB200 is equipped with the remote-control interface EB200R2 (RS232 interface) parameters baud rate, IP address and port number can be set in submenu SETUP REMOTE.

The setting of the IP address and the port number becomes immediately effective. After changing the baud rate, the device must be switched on/off.

4.4 Structure and syntax of the device messages

4.4.1 SCPI introduction

SCPI (Standard Commands for Programmable Devices) describes a standard command set for programming devices, irrespective of the type of device or manufacturer. The goal of the SCPI consortium is to standardize the device-specific commands to a large extent. For this purpose, a model was developed which defines the same functions inside a device or for different devices. Command systems were generated which are assigned to these functions. Thus it is possible to address the same functions with identical commands. The command systems are of a hierarchical structure. Fig. 4-1 illustrates this tree structure using a section of command system SENSE which operates the sensor functions of the devices. The other examples regarding syntax and structure of the commands are derived from this command system.

SCPI is based on standard IEEE 488.2, ie it uses the same syntactic basic elements as well as the common commands defined in this standard. Part of the syntax of the device responses is defined with greater restrictions than in standard IEEE 488.2 (see "Responses to queries" on page 8).

4.4.2 Structure of a command

The commands consist of a so-called header and, in most cases, one or more parameters. Header and parameter are separated by a "white space" (ASCII code 0 to 9, 11 to 32 decimal, eg blank). The headers may consist of several keywords. Queries are formed by directly appending a question mark to the header.

Note:

The commands used in the following examples are not in every case implemented in the device.

Common commands

Common commands consist of a header preceded by an asterisk "*" and one or several parameters, if any.

Examples: *RST RESET, resets the device
 *ESE 253 EVENT STATUS ENABLE, sets the bits of
 the event status enable register
 *ESR? EVENT STATUS QUERY, queries the
 contents of the event status register.

Device-specific commands

Hierarchy: Device-specific commands are of hierarchical structure (see Fig. 4-1). The different levels are represented by combined headers. Headers of the highest level (root level) have only one keyword. This keyword denotes a complete command system.

Example: `SENSe` This keyword denotes the command system `SENSe`.

For commands of lower levels, the complete path has to be specified, starting on the left with the highest level, the individual keywords being separated by a colon ":".

Example: `SENSe:FREQuency:STARt 118 MHz`

This command lies in the third level of the `SENSe` system. It sets the starting frequency of a scan to 118 MHz.

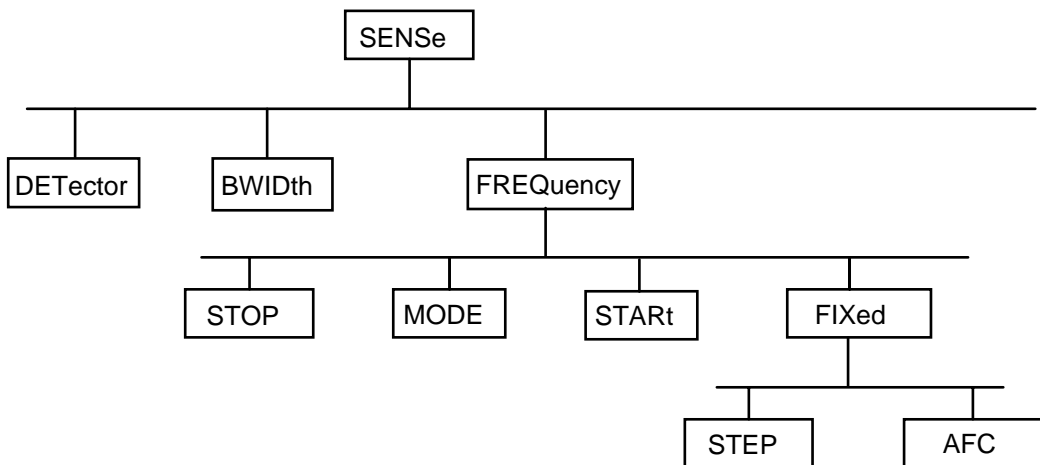

Fig. 4-1: Tree structure of the SCPI command system using the `SENSe` system by way of an example

Some keywords occur at several levels within one command system. Their effect depends on the structure of the command, that is to say, at which position in the header of a command they are inserted.

Example: `OUTPut:OUTPut:SQUelch:STATe ON`

This command contains the keyword `STATe` at the third command level. It defines the state of the `SQUelch` function.

`OUTPut:FILTer:LPAS:STATe OFF`

This command contains the keyword `STATe` at the fourth command level. It defines the state of the AF filter.

Optional keywords: Some command systems permit certain keywords to be optionally inserted into the header or omitted. These keywords are marked by square brackets in the description. The full command length must be recognized by the device for reasons of compatibility with the SCPI standard. Some commands are considerably shortened by these optional keywords.

Example: `[SENSe]:FREQuency[:CW]: STEP [:INCRement]
25 kHz`

This command sets the stepwidth for frequency UP-DOWN to 25 kHz. The following command has the same effect:

`FREQuency:STEP 25 kHz`

Note: *An optional keyword must not be omitted if its effect is specified in detail by a numeric suffix.*

Long and short form: The keywords can be of a long form or a short form. Either the short form or the long form can be entered, other abbreviations are not permissible.

Example: Long form: `STATus:QUESTionable:ENABle 1`

Short form: `STAT:QUES:ENAB 1`

Note: The short form is marked by upper-case letters, the long form corresponds to the complete word. Upper-case and lower-case notation only serve the above purpose, the device itself does not make any difference between upper- and lower-case letters.

Parameter: The parameter must be separated from the header by a "white space". If several parameters are specified in a command, they are separated by a comma ",". A few queries permit the parameters MINimum, MAXimum and DEFault to be entered. For a description of the types of parameter, refer to "Parameters" on page 9.

Example: `SENSe:FREQuency? MAXimum` **Response:** 3000000000

This query requests the maximal value for the input frequency.

Numeric suffix: If a device features several functions or characteristics of the same kind, the desired function can be selected by a suffix added to the command. Entries without suffix are interpreted like entries with the suffix 1.

4.4.3 Structure of a command line

Several commands in a line are separated by a semicolon ";". If the next command belongs to a different command system, the semicolon is followed by a colon.

Example:

```
SENSe:FREQuency:STARt MINimum;:OUTPut:FILTer:LPAS:STATe ON
```

This command line contains two commands. The first command is part of the SENSE system and is used to specify the start frequency of a scan. The second command is part of the OUTPUT system and sets the AF filter.

If the successive commands belong to the same system, having one or several levels in common, the command line can be abbreviated. To this end, the second command after the semicolon starts with the level that lies below the common levels (see also Fig. 4-1). The colon following the semicolon must be omitted in this case.

Example:

```
SENSe:FREQuency:MODE CW;:SENSe:FREQuency:FIXed:AFC ON
```

This command line is represented in its full length and contains two commands separated from each other by the semicolon. Both commands are part of the SOURCE command system, subsystem FREQUENCY, ie they have two common levels.

When abbreviating the command line, the second command begins with the level below SENSE:FREQUENCY. The colon after the semicolon is omitted.

The abbreviated form of the command line reads as follows:

```
SENSe:FREQuency:MODE CW;FIXed:AFC ON
```

However, a new command line always begins with the complete path.

Example: SENSe:FREQuency:MODE CW
 SENSe:FREQuency:FIXed:AFC ON

4.4.4 Responses to queries

A query is defined for each setting command unless explicitly specified otherwise. It is formed by adding a question mark to the associated setting command. According to SCPI, the responses to queries are partly subject to stricter rules than in standard IEEE 488.2.

1 The requested parameter is transmitted without header.

Example: `SENSe:FREQuency:MODe` Response: `SWE`

2. Maximum values, minimum values and all further quantities, which are requested via a special text parameter are returned as numerical values.

Example: `FREQuency? MAX` Response: `3000000000`

3. Numerical values are output without a unit. Physical quantities are referred to the basic units.

Example: `FREQuency?` Response: `100000000` for 100 MHz

4. Truth values <Boolean values> are returned as 0 (for OFF) and 1 (for ON).

Example: `OUTPut:FiLTER:STATe?` Response: `1`

5. Text (character data) is returned in a short form (see also "Parameters" on page 9).

Example: `SENSe:FREQuency:MODe?` Response: `SWE`

4.4.5 Parameters

Most commands require a parameter to be specified. The parameters must be separated from the header by a "white space". Permissible parameters are numerical values, Boolean parameters, text, character strings, block data and expressions. The type of parameter required for the respective command and the permissible range of values are specified in the command description (see "Description of commands" on page 13).

Numerical values Numerical values can be entered in any form, i.e. with sign, decimal point and exponent. Values exceeding the resolution of the device are rounded up or down. The mantissa may comprise up to 41 characters, the exponent must lie inside the value range -999 to 999. The exponent is introduced by an "E" or "e". Entry of the exponent alone is not permissible. In the case of physical quantities, the unit can be entered. Permissible units are as follows:

for frequencies	GHz, MHz or MAHz, kHz and Hz, default unit is Hz
for times	s, ms, μ s, ns; default unit is s
for levels	dBuV; default unit is dBuV
for percentage	PCT, default unit PCT

If the unit is missing, the default unit is used.

Example:

`SENSe:FREQuency 123 MHz = SENSe:FREQuency 123E6`

Special numerical The texts MINimum, MAXimum, UP, DOWN and INFINITY are interpreted as special numerical values.

In the case of a query, the numerical value is provided.

Example: Setting command: `SENSe:GCONtrol MAXimum`

Query: `SENSe:GCONtrol` Response: 100

MIN/MAX MINimum and MAXimum denote the minimum and maximum value.

UP/DOWN UP, DOWN increases or reduces the numerical value by one step. The step width can be specified for some parameter which can be set via UP, DOWN via an allocated step command (see Annex C). Some parameters can only be changed in fixed steps (eg `SENSe:BWIDth UP`).

- INF** **IN**finity stands for $+\infty$. For queries the numerical value 9,9E37 is output. With **MSCAN**, **FSCAN** or **DSCAN**, the **INF** value 9,9E37 is entered in the result buffers **MTRACE** and **ITRACE** to mark the end of range.
- NINF** **Negative IN**finity (**NINF**) stands for $-\infty$. For queries the numerical value -9,9E37 is output. In a measured value query, this value will be output if owing to the device setting the measurement cannot be carried out.
- NAN** **Not A Number (NAN)** stands for the value 9,91E37. **NAN** is only sent as a device response. This value is not defined. Possible causes are the division of zero by zero, the subtraction of infinity from infinity and the display of missing values (eg with **TRACe[:DATA]?**).

Boolean parameters Boolean parameters represent two states. The **ON** state (logically true) is represented by **ON** or a numerical value unequal to 0. The **OFF** state (logically untrue) is represented by **OFF** or the numerical value 0. 0 or 1 is provided in a query.

Example: Setting command:

`OUTPut:FILTEr:STATe ON`

Query: `OUTput:FILTER:STATe?`

Response: 1

Text Text parameters (character data) observe the syntactic rules for keywords, i.e. they can be entered using the short or long form. Like any parameter, they have to be separated from the header by a "white space". In the case of a query, the short form of the text is provided.

Example: Setting command: `SENSE:FREQuency:MODE FIXed`

Query: `SENSE:FREQuency:MODE?` Response `FIX`

Strings Strings must always be entered in quotation marks (' or ").

Example: `SYSTem:SECurity: OPTion "123ABC"` or

`SYSTem:LANGUage 'English'`

Block data

Block data (Definite Length Block) are a transmission format which is suitable for the transmission of large amounts of data. A command using a block data parameter has the following structure:

Example: `HEADer:HEADer #45168xxxxxxxx`

ASCII character # introduces the data block. The next number indicates how many of the following digits describe the length of the data block. In the example the 4 following digits indicate the length to be 5168 bytes. The data bytes follow. During the transmission of these data bytes all End or other control signs are ignored until all bytes are transmitted. Data elements comprising more than one byte are transmitted with the byte being the first which was specified by SCPI command "FORMat:BORDER".

Expressions

Expressions must always be in brackets. The device requires this data format for the indication of channel lists. A channel list always starts with @ followed by a path name or channel numbers or ranges of channel numbers.

Example: `ROUTe:CLOSe (@23)`

4.4.6 Overview of syntax elements

The following survey offers an overview of the syntax elements.

- :** The colon separates the key words of a command.
In a command line the colon after the separating semicolon marks the uppermost command level.

- ;** The semicolon separates two commands of a command line. It does not alter the path.

- ,** The comma separates several parameters of a command.

- ?** The question mark forms a query.

- *** The asterisk marks a common command.

- "** Quotation marks introduce a string and terminate it.

- #** ASCII character # introduces block data.

- A "white space" (ASCII-Code 0 to 9, 11 to 32 decimal, e g blank) separates header and parameter.

- ()** Brackets enclose an expression (channel lists).

4.5 Description of commands

Note: For overview of commands see tables in Annex C.

4.5.1 Notation

In the following sections, all commands implemented in the device are described in detail. The notation corresponds to a large extent to that of the SCPI standards. The SCPI conformity information can be taken from the list of commands in Annex C.

Indentations The different levels of the SCPI command hierarchy are represented in the description by means of indentations to the right. The lower the level is, the further is the indentation to the right. Please observe that the complete notation of the command always includes the higher levels as well.

Example: `SENSe:FREQuency:MODE` is indicated in the description as follows:

SENSe	first level
. :FREQuency	second level
. . :MODE	third level

Upper-/lower-case notation

Upper/lower-case letters serve to mark the long or short form of the key words of a command in the description (see next section). The device itself does not distinguish between upper- and lower-case letters.

Special characters | A selection of keywords with an identical effect exists for some commands. These keywords are given in the same line and are separated by a vertical stroke. Only one of these keywords has to be indicated in the header of the command. The effect of the command is independent of the keywords being indicated.

Example: SENSE

```
:FREQuency
:CW|:FIXed
```

The two following commands of identical meaning can be formed. They set the frequency of the device to 123 MHz:

```
SENSe:FREQuency:CW 123E6 = SENSe:FREQuency:FIXed 123E6
```

A vertical stroke in indicating the parameters marks alternative possibilities in the sense of "or". The effect of the command is different, depending on which parameter is entered.

Example: Selection of parameter for command

```
SENSe:GCONTRol:MODE    FIXed |MGC AUTO |AGC
```

If the parameter `FIXed` is selected, the gain is determined by the MGC voltage. In case of `AUTO` the gain depends on the signal.

The two parameters `MGC` and `AGC` are synonymous for `FIXed` and `AUTO`.

[] Keywords in square brackets can be omitted in the header (see "Common commands" on page 15). The device has to accept the full command length due to reason of compatibility to SCPI standard.

Parameters in square brackets can also be optionally inserted into the command or can be omitted.

{ } Parameters in braces can be inserted in the command either with the options not at all, once or several times.

4.5.2 Common commands

The common commands are taken from the IEEE 488.2 (IEC 625-2) standard. A particular command has the same effect on different devices. The headers of these commands consist of an asterisk "*" followed by three letters. Many common commands concern the "Status reporting system" on page 127.

Command	Parameter	Unit	Remarks
*CLS			no query
*ESE	0 to 255		
*ESR?			only query
*IDN?			only query
*IST?			only query
*OPC			
*OPT?			only query
*PRE	0 to 255		
*RST			no query
*SRE	0 to 255		
*STB?			only query
*TRG			no query
*TST?			only query
*WAI			

*CLS

CLEAR STATUS sets the status byte (STB), the standard event register (ESR) and the EVENT sections of the QUESTIONable and the OPERATION register to zero. The command does not alter the mask and transition parts of the registers. It clears the output buffer.

*ESE 0 to 255

EVENT STATUS ENABLE sets the event status enable register to the value indicated. Query *ESE? returns the contents of the event status enable register in decimal form.

*ESR?

STANDARD EVENT STATUS QUERY returns the contents of the event status register in decimal form (0 to 255) and subsequently sets the register to zero.

***IDN?**

IDENTIFICATION QUERY queries unit about identification.

The output of the unit can be:

"ROHDE&SCHWARZ,EB200,105.050/003,01.00-4052.4654.00

105050/003 is the serial number of the unit

02.72 is the version number of the firmware of the main processor (EB200P1)

4052.4654.00 is the ident number of the software for the main processor (EB200P1)

***IST?**

INDIVIDUAL STATUS QUERY states the contents of the IST flags in decimal form (0 | 1).

***OPC**

OPERATION COMPLETE sets the bit in the event-status register to 0 if all previous commands were carried out. This bit can be used for triggering a service request (see "Status reporting system" on page 127).

***OPC?**

OPERATION COMPLETE QUERY writes the message '1' into the output buffer as soon as all previous commands were carried out (see "Status reporting system" on page 127).

***OPT?**

OPTION IDENTIFICATION QUERY queries about the options in the unit and outputs a list of installed options. The options are separated by a comma.

Explanation for the output characters:

SU = internal IF panorama module

BP = Battery Pack

DS = RF Spectrum DIGI-Scan (software option)

ER = Expansion RAM

CM = Coverage Measurement (software option)

FS = Field Strength Measurement (software option)

Example of response from the unit: 0,BP,DS,ER,0,FS

***PRE 0 to 255**

PARALLEL POLL ENABLE sets parallel poll enable register to the value indicated. Query *PRE? returns the contents of the parallel poll enable register in decimal form.

***RST**

RESET sets the device to a defined default status. The default setting is indicated in the description of the commands.

***SRE 0 to 255**

SERVICE REQUEST ENABLE sets the service request enable register to the value indicated. Bit 6 (MSS mask bit) remains 0. This command determines under which conditions a service request is triggered. Query ***SRE?** reads the contents of the service request enable register in decimal form. Bit 6 is always 0.

***STB?**

READ STATUS BYTE QUERY reads out the contents of the status byte in decimal form.

***TRG**

TRIGGER triggers the same actions as the **INITiate:CONM[:IMMediate]** command.

***TST?**

SELFTEST QUERY triggers the module state test and yields a figure which is to be interpreted as the bit field:

Result = 0 -> all modules ok

Result \neq 0 -> fault in one or several modules. The information about the possible error can be queried by means of the **SYSTem:ERRor?** Command.

***WAI**

WAIT-to-CONTINUE only permits the servicing of the subsequent commands after all preceding commands have been executed and all signals have settled (also see "Status reporting system" on page 127 and ****OPC**").

4.5.3 ABORt subsystem

ABORt

Stop command for measurement. This command stops an active scan.

Parameters:

none

**RST state:*

none, as command is an event

Example:

ABORt

4.5.4 CALCulate subsystem

CALCulate

```

. :IFPan
. . :AVERage
. . . :TIME <numeric_value>

```

Setting of the averaging time for the SCALar averaging procedure

Parameter:

<numeric_value> averaging time in steps of 0, 100, 500 ms

Remark:

For MAIN CPU versions > 1.18 this command not only has effect on the averaging time of the IF-panorama but also on the global measuring time. Thus the original time grading (0, 100, 500 ms) is discarded (see "MEASure subsystem" on page 40").

For reasons of compatibility with versions ≤ 1.18 , entering the averaging time = 0 means the same as the command `CALCulate:IFPan:AVERage:TYPE OFF`.

**RST state:*

0

Example

```
CALCulate:IFPan:AVERage:TIME 0.1
```

```

. . . :TIME?

```

Query of the set averaging time for the SCALar averaging procedure

Parameters:

none

Result:

Averaging time in seconds

Remark:

For reasons of compatibility, for MAIN CPU versions > 2.31 this command reports the global measuring time unless `CALCulate:IFPan:AVERage:TYPE?` is set to OFF.

Example:

```
CALCulate:IFPan:AVERage:TIME? -> 0.1
```

. . . :TYPE MINimum|MAXimum|SCALar|OFF

Setting of the averaging procedure for the IF-panorama data

Parameters:

MINimum	MIN hold function is on
MAXimum	MAX hold function is on
SCALar	AVG averaging function is on
OFF	Switching on the Clear Write function

Note:

For the SCALar averaging procedure the averaging time and measuring time can be set by commands CALCulate:IFPan:AVERAge:TIME and MEASure:TIME, respectively.

**RST state:*

OFF

Example:

CALCulate:IFPan:AVERAge:TYPE MAXimum

. . . :TYPE?

Query of the averaging procedure for the IF-panorama data

Result:

MIN	MIN hold function is on
MAX	MAX hold function is on
SCAL	AVG averaging function is on
OFF	Switching on the Clear Write function

Example:

CALCulate:IFPan:AVERAge:TYPE? -> MAX

. . :CLEAr

Restart of the MIN or MAX hold function for the IF-panorama data

Parameters:

none

Example:

CALCulate:IFPan:CLEAr

. . :MARKer:MAXimum[:PEAK]

Centering of the IF-panorama spectrum to the absolute level maximum

Parameters:
none

Example:
CALCulate:IFPan:MARKer:MAXimum

. . :MARKer:MAXimum:LEFT

Centering of the IF-panorama spectrum to the next relative level maximum left of the marker when the squelch is off. When it is on the center frequency is set to the next level maximum to the left which is above the squelch line.

Parameters:
none

Example:
CALCulate:IFPan:MARKer:LEFT

. . :MARKer:MAXimum:RIGHT

Centering of the IF-panorama spectrum to the next relative level maximum right of the marker when the squelch is off. When it is on the center frequency is set to the next level maximum to the right which is above the squelch line.

Parameters:
none

Example:
CALCulate:IFPan:MARKer:RIGHT

. :DSCan
. . :AVERage
. . . :TYPE MAXimum|OFF

Setting of the display mode of the DSCan spectrum

Parameters:

MAXimum indication of maximum values
OFF indication of current values

**RST state:*

OFF

Example:

CALCulate:DSCan:AVERage:TYPE MAXimum

. . . :TYPE?

Query of the display mode of the DSCan spectrum

Result:

MAX indication of maximum values
OFF indication of current values

Example:

CALCulate:DSCan:AVERage:TYPE? -> MAX

. . :CLEar

Clears the DSCan spectrum. If the display has been selected to be MAXimum, maximum value generation restarts.

Parameters:

none

Example:

CALCulate:DSCan:CLEar

. . :MARKer:MAXimum[:PEAK]

The frequency marker jumps to the absolute level maximum in the DSCan spectrum.

Parameters:

none

Example:

CALCulate:DSCan:MARKer:MAXimum

. . :MARKer:MAXimum:NEXT

The frequency marker jumps to the next relative level maximum right of the marker within the DSCan spectrum when the squelch is off. When it is on the frequency marker is set to the next level maximum to the right that is above the squelch line. If there is no further level maximum right of the current level maximum, the frequency marker jumps to the first level maximum to the left within the DSCan spectrum.

Parameters:

none

Example:

CALCulate:IFPan:MARKer:RIGHT

4.5.5 DIAGnostic subsystem

DIAGnostic[:SERVice]

- . :INFO
- . . :SDATe<numeric_suffix>?

Query of software-generation date

If a module is not available, a zero strings (") is returned and the error message HW MISSING will be generated.

Parameters:

The processor is selected via the <numeric suffix>:

1 or no <numeric suffix>	main processor (EB200P1)
2	DSP IF Section (EB200Z1)
3	DSP IF Panorama (EB200SU)
4	Front Panel Control Unit (EB200F1)

Result:

<year>, <month>, <day>

<year> = **1900** to

<month> = **1 to 12**

<day> = **1 to 31**

Example:

DIAGnostic:INFO:SDATe1? -> 1998,10,2

- . . :SVERsion<numeric_suffix>?

Query of software version

If a module is not available, a zero string (") is returned and the error message HW MISSING will be generated.

Parameters:

The parameter is selected via the <numeric suffix>:

1 or no <numeric suffix>	main processor (EB200P1)
2	DSP IF Section (EB200Z1)
3	DSP IF Panorama (EB200SU)
4	Front Panel Control Unit (EB200F1)
5	DC/DC Converter (EB200 DC)

Result:

Software version and identification number of software in format Vxx.yy-aaaa.bbbb.cc (also see *IDN?)

Note:

The query with <numeric suffix> = 5 (DC/DC converter controller) brings up only the version number without the stock number.

Example:

DIAGnostic:INFO:SVERsion1? -> V01.00-4052.4654.00

. :MONitor? <module>

Output of test point information of one or all modules recognized.

Parameters:

<code><module></code>	information relating to module to be queried:
	P1 Processor
	V1 Preselection
	S1 Standard frontend 1
	S2 Standard frontend 2
	Z1 IF section
	DC DC/DC converter
	SU IF panorama
	ALL Output of test point information of all modules

Result:

If the output format is set to ASCII, all information relating to the test points of a known module are output in a table.

The table comprises the following columns:

module identification, test point name, symbol for test point state, current voltage in mV, lower limit, upper limit

Meaning of symbols for the test point state:

- “ ” = OK, test point voltage within limits
- “^” = test point voltage is greater than the upper limit
- “v” = test point voltage is less than the upper limit

If the limits are irrelevant in the current operating mode, no limits will be output.

Example:

```
DIAGnostic:MONitor? S2 ->
S2      TP_2ND_IF      2583  ( 2300 / 2800 )
S2      TP_3RD_IF      2407  ( 2120 / 2600 )
S2      TP_SAM_LEV     2179  ( 200 / 4080 )
S2      TP_2NDLOLEV    1534  ( 700 / 3200 )
S2      TP_3RDLOLEV     977  ( 300 / 1300 )
S2      TP_2NDLOPLL    1882  ( 1000 / 3000 )
S2      TP_VXO_PLL     v      1  ( 200 / 3400 )
S2      TP_EXT_REF     v      1  ( 2000 / 4000 )
```

If the output format is set to binary format, a binary data block will be output which is similar to the structure described under "4.4.5 Parameters" followed by the test point descriptions with:

- 2 bytes module identifiers
- 12 bytes test point name
- 2 bytes current value in mV
- 1 byte OK flag for test point voltage (0= OK, 1 = too low, 2 = too high)
- 1 byte validity flag for limit values (0 = invalid, 1 = valid)
- 2 bytes minimum value in mV
- 2 bytes maximum value in mV

Example:

```
DIAGnostic:MONitor? S2 -> #3180xxxxxx
```

. **[[:MEASure]:TPOint[<numeric_suffix>]? <module>**

Output of the voltage at a test point on a module. With <numeric_suffix> one of the test points (1 to 8) on the module is selected.

Parameter:

<module>	Indication of module to be queried
	P1 Processor
	V1 Preselection
	S1 Standard frontend 1
	S2 Standard frontend 2
	Z1 IF section
	DC DC/DC converter
	SU IF panoramic unit

Result:

Instantaneous test point voltage in mV

Example:

DIAGnostic:TPOint3? S2 -> 2163

4.5.6 DISPlay subsystem

DISPlay

. :BRIGhtness <numeric_value>|MINimum|MAXimum

Controls the brightness of the display backlighting

Parameters:

<numeric_value>	brightness of backlighting from 0 to 1 0 = backlighting off 1 = full backlighting
MINimum MAXimum	backlighting off full backlighting

Remark:

The brightness can be set in 7 discrete steps. Intermediate values are therefore rounded to the nearest discrete value.

**RST state:*

1.0

Example:

DISPlay:BRIGhtness 0.5

. :BRIGhtness? [MINimum|MAXimum]

Query of brightness of display backlighting

Parameter:

none	query of current brightness
MINimum MAXimum	query of lowest highest brightness

Result:

Brightness of backlighting from 0 to 1

Example:

DISPlay:BRIGhtness? -> 0.5

. :BRIGhtness:DWELl <numeric_value>|MINimum|MAXimum|INFinity

Controls the switch-on time of display backlighting. When the switch-on time has elapsed, the backlighting is switched off. The switch-on time is started again after every keystroke.

Parameter:

<numeric_value>	switch-on time in seconds (it is rounded to values 30,60,180,300,600,1200)
MINimum MAXimum	lowest or highest switch-on time
INFinity	backlighting is never switched off.

Remark:

The switch-on time can be set in 7 discrete steps (30,60,120,180,300,600,1200 seconds). The parameter is therefore rounded to the nearest discrete value.

**RST state:*

INFinity

Example:

DISPlay:BRIGhtness:DWELl 45

. :BRIGhtness:DWELl? [MINimum|MAXimum]

Query of switch-on time of display backlighting

Parameters:

none	query of current switch-on time
MINimum MAXimum	query of lowest highest switch-on time

Result:

Switch-on time in seconds. 9.9E37 is output as an infinite number

Example:

DISPlay:BRIGhtness:DWELl? -> 3.0

. :CMAP:DEFault

Selection of normal display representation

Parameters:

none

**RST state:*

NORMal

Example:

DISPlay:CMAP:DEFAULT

. :CMAP NORMal|INVerted

Selection of normal or inverted display representation

Parameters:

NORMal background white, letters and lines black

INVerted background black, letters and lines white

**RST state:*

NORMal

Example:

DISPlay:CMAP NORMAL

. :CMAP?

Query of the currently selected display representation

Parameters:

none

Result:

NORM background white, letters and lines black

INV background black, letters and lines white

Example:

DISPlay:CMAP? -> NORMAL

. :ENABle <Boolean>

Enable or disable the manual control and display (display, rollkey and keys).

CONTROLLED BY REMOTE is displayed on the front panel in the "disable" state. The string can be configured by means of the DISPLAY:ENABle:LABel command. This command is advantageous if, in systems, EB200 is exclusively controlled by Remote.

When the front-panel controls are switched off, additional computing power becomes available in the processor and time-critical operations (scans, transmission of large volumes of data) run much more quickly.

Parameters:

ON	enable manual control
OFF	disable manual control

*RST state:

ON

Example:

```
DISPlay:ENABle ON
```

. :ENABle?

Query of state of manual control .

Parameters:

none

Result:

1	manual control enabled
0	manual control disabled

Example:

```
DISPlay:ENABle? -> 1
```

. :ENABLE:LABel<string>

Entry of a user-defined information string displayed on the front panel in the DISPlay:ENABLE OFF state. The user is informed why the system under remote control has switched the display off and why manual control is currently disabled.

Parameters:

<string> ASCII string with 30 characters at max.

**RST state:*

"CONTROLLED BY REMOTE"

Example:

DISPlay:ENABLE:LABel "THIS IS A TEST"

. :ENABLE:LABel?

Query of currently set information string.

Parameters:

none

Result:

<String> ASCII string with 30 characters at max.

Example:

DISPlay:ENABLE:LABel? -> "THIS IS A TEST"

. :MENU[:NAME] <menu_name>

Selection of a specific display representation from the given list.

Parameters:

<menu_name>	DEFAULT	display of frequency, offset and level
	IFPAN	starts the option EB200SU (IF panorama) and preferably the display of the IF panorama data
	LEVEL	preferably level meter display
	TONE	zoomed level display
	FREQ	full-screen of frequency

**RST state:*

DEFAULT

Example:

DISPlay:MENU LEVEL

. :MENU[:NAME]?

Query of currently selected display.

Parameters:

none

Result:

<menu_name> List (see above)

Example:

DISPlay:MENU? -> LEVEL

4.5.7 FORMat subsystem

FORMat

. :BORDER NORMal|SWAPped

Specifies whether binary data is first to be transferred with low or high byte.

Note:

This command only has an effect upon the trace data. For UDP data there is a separate setting possibility, described in Annex F (Datagram Communication).

Parameters:

NORMal	MSB -> ... -> LSB
SWAPped	LSB ->... -> MSB

**RST state:*

NORMal

Example:

FORMat:BORDER SWAPped

. :BORDER?

Query of output order for binary data

Parameters:

none

Result:

NORM, SWAP

Result:

FORMat:BORDER? -> SWAP

. [:DATA] ASCii|PACKed

Specifies the output format of the following queries:

SENSe:DATA?

TRACe:DATA?

Parameters:

ASCii	output with ASCII format
PACKed	output with internal binary data format

**RST state:*

ASCii

Example:

FORMat PACKed

. [:DATA]?

Query of output format of the above-mentioned queries

Parameters:
none

Result:
ASC, PACK

Example:
FORMat? -> PACK

. :DIAGnostic:MONitor ASCii|PACKed

Sets the output format for the query `DIAGnostic:MONitor?`.

Parameters:
ASCii output in ASCII format
PACKed output in internal binary data format

**RST state:*
ASCii

Example:
FORMat:DIAGnostic:MONitor PACKed

. :DIAGnostic:MONitor?

Query of the above stated output format

Parameters:
none

Result:
ASC, PACK

Example:
FORMat:DIAGnostic:MONitor? -> PACK

. :MEMory ASCii|PACKed

Specifies the output format of the queries MEMory:CONTents?

Parameters:

ASCii	output in ASCII format
PACKed	output in internal binary data format

**RST state:*

ASCii

Example:

FORMat:MEMory PACKed

. :MEMory?

Query of output format of above-mentioned queries

Parameters:

none

Result:

ASC, PACK

Example:

FORMat:MEMory? -> PACK

. :SREGister ASCii|BINary|HEXadecimal

Specifies with which data format the queries of all CONDition, EVENT, ENABle, PTRansition, NTRansition registers and all IEEE-488.2 status registers are to be carried out.

Parameters:

ASCii	output as decimal figure in ASCII code (eg 128)
BINary	output as binary figure in ASCII code (eg #B100000000000000)
HEXadecimal	output as hexadecimal figure in ASCII code (eg #H8000)

**RST state:*

ASCii

Example:

FORMat:SREGister HEXadecimal

. :SREGister?

Query with which data format the above-mentioned queries are carried out

Parameters:
none

Result:
ASC, BIN, HEX

Example:
FORMat:SREGister? -> HEX

4.5.8 INITiate subsystem

INITiate

. [:IMMEDIATE]

Request to provide a current measured value. Also serves as start command for the different SCAN modes.

If `SENSe:FREQuency:MODE` set to `CW|FIXed`, then with each `INITiate` command a measurement is carried out, the result possibly being stored in the `MTRACE` or `ITRACE`.

If `SENSe:FREQuency:MODE` is set to `SWEep|MSCan|DSCan`, then the respective SCAN is started, a measurement being carried out with each step.

If eg command `TRACE:FEED:CONTRol MTRACE`, `ALWays` is used to enable the path to the buffer `MTRACE`, the results are stored in `MTRACE`.

Parameters:

none

Example:

```
INITiate
```

. :CONM

. . [:IMMEDIATE]

Command to **CON**tinue a **M**asurement. Is also used as continue command for different SCAN types. `MTRACE` and `ITRACE` data sets are not deleted and are filled with measurement results according to the setting. I.e:

If `SENSe:FREQuency:MODE` is set to `CW|FIXed`, a measurement is carried out and possibly stored in `MTRACE` or `ITRACE`.

If `SENSe:FREQuency:MODE` is set to `SWEep|MSCan`, a measurement is carried out for each step and stored in `MTRACE` or `ITRACE`. As an alternative, the command `*TRG` or the interface message Group Execute Trigger (`GET`) can be used. The response time is the shortest for a `GET` which is why a `GET` should always be used for time-critical measurements.

Parameters:

none

Example:

```
INITiate:CONM
```

4.5.9 INPut subsystem

INPut

- . :ATTenuation
- . . :AUTO <Boolean>

Setting attenuation so that the best dynamic range is obtained; explicit switch on/off of attenuator sets AUTO to OFF

Parameters:

ON	attenuation is coupled to input-signal strength
OFF	attenuation is manually switched

**RST state:*

ON

Example:

INPut:ATTenuation:AUTO ON

- . . :AUTO?

Query of the automatically attenuation setting

Parameters:

none

Result:

Attenuation is automatically switched 1
Attenuation is manually switched 0

Example:

INPut:ATTenuation:AUTO? -> 1

- . . :STATe <Boolean>

Switch on/off of input attenuator

Parameters:

ON	attenuator on
OFF	attenuator off

**RST state:*

level-dependent (because of INPut:ATTenuation:AUTO ON after *RST)

Example:

INPut:ATTenuation:STATe ON

. . . :STATE?

Query of the input attenuator setting

Parameters:

none

Result:

Attenuator on	1
Attenuator off	0

Example:

INPut:ATTenuation:STATE? -> 1

4.5.10 MEASure subsystem

(See also Annex E (Measuring Functions))

MEASure

. :MODE CONTInuous|PERiodic

Setting of continuous or periodic measuring mode

In the **PERiodic** measurement mode all detectors are discharged after the measuring time has elapsed, and the next measurement is started. Only the individual measured values per measuring period are displayed.

If the path to the result buffer `MTRACE` is enabled by command `TRACE:FEED:CONTRol MTRACE, ALWays`, a measured value is stored in `MTRACE` each time the measuring time has elapsed.

In the **CONTInuous** measuring mode the measuring detector is read out every 200 msec, irrespective of the measuring time. These current measured values are displayed.

The measuring time has an effect on the level detectors. With `AVG` the measuring time determines the averaging time. With `PEAK` the measuring time determines the fall time. With `FAST` the measuring time does not have any impact since it is only the current value which is measured.

If the path to the result buffer `MTRACE` is enabled by command `TRACE:FEED:CONTRol MTRACE, ALWays`, a current measured value can be stored in `MTRACE`.

Parameters:

CONTInuous	continuous measurement
PERiodic	periodic measurement

*RST state:

CONTInuous

Example:

```
MEASure:MODE PERiodic
```

. :MODE?

Query of the set measuring mode

Parameters:

none

Result:

CONT	continuous measurement
PER	periodic measurement

Example:

```
MEASure:MODE? -> PER
```

. :TIME <numeric_value>|MINimum|MAXimum|DEFault

Setting of the measuring time for all measuring functions

The set measuring time also has an impact on the averaging time of the IF-panorama data.

Note:

As from MAIN CPU version 2.31, the version of the DSP software (IF DSP) indicates what kind of DDC is fitted in the IF section. When the displayed version is smaller than V03.00, then the IF section contains a DDC1. For versions from V03.00 onwards the IF section holds a DDC2. The equipment with DDC2 is a prerequisite for future software options such as EB200CM and the configuration of a measuring time.

Note:

Selecting a measuring time which really makes sense is the user's responsibility. Too short a measuring time will give rise to incorrect results.

Parameters:

<numeric_value>	measuring time in seconds
MINimum MAXimum	shortest/longest measuring time
DEFault	preset measuring times

*RST state:

DEFault

Example:

MEASure:TIME 200 ms

. :TIME? [MINimum|MAXimum]

Query of the set measuring time

Parameters:

none	query of the current measuring time
MINimum MAXimum	query of the shortest/longest measuring time

Result:

Measuring time in seconds; with the default measuring time being set DEF will be output.

Example:

MEASure:TIME? -> 0.2

4.5.11 MEMory subsystem

This subsystem contains all the functions necessary to operate the EB200 memory locations. The memory locations are addressed with the text (see "Parameters" on page 9) MEM0 to MEM999 (memory location 0 to memory location 999). Some commands allow the receiver (data set of receiver settings) to be addressed by `Character Data RX`, the currently set memory location by `CURRENT` and the next free memory location by `NEXT`.

The number of the currently active memory location can also be queried by the `MSCAN:CHAnel?` command.

MEMory

. :CLEar <name> [,<count>|MAXimum]

Clearing the contents of a memory location. A certain number of memory locations to be cleared may also be specified.

Parameters

<name>	MEM0 to MEM999 CURRENT
<count>	number of memory locations to be cleared from memory location <name>; as a default value <count> = 1 is accepted
MAXimum	clearing all memory locations from <name> to the last memory location

Example:

```
MEMory:CLEar MEM123
```

. :COPY <src_name>, <dest_name>

Copy the memory contents from src to dest

Parameters:

<src_name> RX	MEM0 to MEM999 RX CURRENT
<dest_name> RX	MEM0 to MEM999 RX CURRENT NEXT

Example:

```
MEMory:COPY MEM123, MEM10
```

. :CONTents <name>,<mem_paras>|<packed_struct>

Loading a memory location

As an alternative to the parameter field (<mem_paras>) a <Definite Length Block> can be transferred with binary data.

Parameters:

<name> MEM0 to MEM999 | RX | CURRENT | NEXT
 <mem_paras> <F>, <THR>, <DEM>, <BW>, <ANT>, <ATT>, <ATTA>, <SQUC>, <AFC>, <ACT>

<F> frequency (see SENS:FREQ:CW)
 <THR> squelch threshold (see OUTP:SQU:THR)
 <DEM> type of demodulation (see SENS:DEM)
 <BW> bandwidth (see SENS:BWID)
 <ANT> antenna number (see ROUT:SEL)
 <ATT> attenuator (see INP:ATT:STAT)
 <ATTA> attenuator auto (see INP:ATT:AUTO)
 <SQUC> squelch function (see OUTP:SQU:STAT)
 <AFC> AFC function (see (SENS:FREQ:CW:AFC)
 <ACT> setting/resetting the memory to scan (ON/OFF or 1/0)

<packed_struct> binary data set as <Definite Length Block> with the following structure:

Frequency in Hz 4 bytes = unsigned long integer
 Squelch threshold in 1/10 dBuV 2 bytes = signed integer
 Demodulation type 2 bytes = meaning:
 0 = FM, 1 = AM, 2 = PULSe, 3 = CW, 4 = USB, 5 = LSB, 6 = IQ

Bandwidth 2 bytes = meaning:
 0 = 0.15 kHz, 1 = 0.3 kHz, 2 = 0.6 kHz, 3 = 1.5 kHz,
 4 = 2.4 kHz, 5 = 6 kHz, 6 = 9 kHz, 7 = 15 kHz, 8 = 30 kHz,
 9 = 50 kHz, 10 = 120 kHz, 11 = 150 kHz,

Antenna number 1 byte = unsigned character 0 to 99
 Attenuator 1 byte = unsigned character (1 = on / 0 = off)
 Attenuator auto 1 byte = unsigned character (1 = on / 0 = off)
 Squelch function 1 byte = unsigned character (1 = on / 0 = off)
 AFC function 1 byte = unsigned character (1 = on / 0 = off)
 Set/Reset memory 1 byte = unsigned character (1 = set / 0 = reset)

 Total number of bytes = 16

Notes:

- When loading the receiver data set (RX) the parameter <ACT> is ignored. It must, however, be specified.
- When loading with <packed_struct> the byte order within the 2- and 4-byte elements is determined by the setting command FORMat: BORDer.

*RST state:

The contents of the memory locations is kept after *RST.

Example:

MEMory:CONTents MEM1,98.5 MHz,34, FM ,100 kHz,(@1),1,OFF,ON,OFF,ON

. :CONTents? <name>|RX

Query of contents of memory location

Parameters:

<name> MEM0 to MEM999 | RX | CURRENT

Result:

Depending on the setting by the command FORMat:MEMory either an ASCII data set or a binary data set is output:

The ASCII data set has the following structure:

<F>	, <THR>	, <DEM>	, <BW>	, <ANT>	, <ATT>	, <ATTA>	, <SQUC>	, <AFC>	, <ACT>
<F>	frequency (see SENS:FREQ:CW?)								
<THR>	squelch threshold (see OUTP:SQU:THR?)								
<DEM>	demodulation type (see SENS:DEM?)								
<BW>	bandwidth (see SENS:BWID?)								
<ANT>	antenna number (see ROUT:CLOS:STAT?)								
<ATT>	attenuator (see INP:ATT:STAT?)								
<ATTA>	attenuator auto (see INP:ATT:AUTO?)								
<SQUC>	squelch function (see OUTP:SQU:STAT?)								
<AFC>	AFC function (see (SENS:FREQ:CW:AFC?)								
<ACT>	set/reset for scan (1/0)								

The binary data set is transferred as a <Definite Length Block> and has to be interpreted according to the above-mentioned format.

Notes:

- During query of the receiver data set (RX) the parameter <ACT> is not defined and has to be ignored.
- When trying to read out an empty memory location the error message "MEMORY EMPTY" is generated.

Example:

```
MEMory:CONTents? MEM1 -> 98500000,34,FM,100000,#14(@1),0,1,1,0,1
```

. . :MPAR <name>,<ACT>

Setting the memory location parameter (MPAR = MemoryPARameter) <ACT>

Parameters:

<name> MEM0 to MEM999 | CURRENT
<ACT> setting/resetting the memory to the scan (ON/OFF or 1/0)

Example:

```
MEMory:CONTents:MPAR MEM1, OFF
```

. . . :MPAR? <name>

Query of memory-location parameter <ACT>

Parameters:

<name> MEM0 to MEM999 | CURRENT

Result:

<ACT> set/reset for scan (1/0)

Example:

MEMory:CONTents:MPAR? MEM1 -> 0

. . . :EXCHange <name1>, <name2>

Exchange of contents of two memory locations

Parameters:

<name1> MEM0 to MEM999 | RX | CURRENT

<name2> MEM0 to MEM999 | RX | CURRENT

Example:

MEMory:EXCHange MEM123, RX

4.5.12 OUTPut subsystem

OUTPut

. :AUXMode FREQUENCY|ANTCtrl

The AUX mode switch determines whether the frequency in BCD or the antenna number in BCD and the CTRL byte should be output at the rear-panel AUX connector X8. The FREQUENCY setting is to be used together with DF Unit EBD190.

Parameter:

FREQUENCY	Frequency output at AUX 4-digits in BCD (1, 10, 100, 1000 MHz)
ANTCtrl	Output of antenna number in 2-digit BCD (ANTA1...ANTA80) Output of binary CTRL bytes (CTRL1 CTRL8)

**RST status:*

ANTCtrl

Example:

OUTPut:AUXMode FREQUENCY

. :AUXMode?

Query of the AUX mode switch setting

Parameter:

None

Result:

FREQ	frequency output
ANTC	output of antenna number and CTRL byte

Example:

OUTPut:AUXMode? → FREQ

:BITAux [<numeric_suffix>]**. . [:STATe] <Boolean>**

Sets the AUX bits at the rear panel

<numeric_suffix>

- 1 byte 1 corresponds to CTRL1 at X8.8'AUX'
- 2 byte 2 corresponds to CTRL2 at X8.27'AUX'
- 3 byte 3 corresponds to CTRL3 at X8.9'AUX'
- 4 byte 4 corresponds to CTRL4 at X8.28'AUX'
- 5 byte 5 corresponds to CTRL5 at X8.10'AUX'
- 6 byte 6 corresponds to CTRL6 at X8.29'AUX'
- 7 byte 7 corresponds to CTRL7 at X8.11'AUX'
- 8 byte 8 corresponds to CTRL8 at X8.30'AUX'

**Parameters:*

ON Bit set to high level
 OFF Bit set to low level

RST state

OFF

Example:

OUTPut3 : BITAux2 ON

. . [:STATe] ?

Query of AUX bits at the rear panel

Result:

1 "high" level bit set
 0 "low" level bit set

Parameters:

none

Example:

OUTPut : BITAux2? → 1

- . **:BYTAux**
- . . **[:STATe] <numeric_value>**

Sets the 8 AUX bits by a single byte command

Parameters:

<numeric_value> value of the AUX bytes (0 to 255, #H00 to #HFF or #B0 to #B11111111)

**RST state:*

0

Example:

OUTPut : BYTAux 7

- . **:BYTAux**
- . . **[:STATe]?**

Query of the 8 AUX bits by a single byte command

Parameters:

none

Result:

Depending on the settings by the FORMat : SREGister command , the contents of the register is transferred in decimal, binary or hexadecimal form in the ASCII code.

Example:

OUTPut : BYTAux? → 7

- . **:SQUelch**
- . . **[:STATe] <Boolean>**

Switch on/off of squelch

Parameters:

ON squelch on
OFF squelch off

**RST state:*

OFF

Example:

OUTPut:SQUelch ON

. . [:STATe]?

Query of squelch setting

Parameters:

none

Result:

1	squelch on
0	squelch off

State:

OUTPut:SQUelch? -> 1

. . :CONTrol MEMory|NONE

Selection of the source for the operating state after switching the unit on, when reading the memory locations by the MEMory:CoPY command, when using the RCL key or when running memory scan.

Parameters:

MEMory	squelch state and squelch value are read out of the memory locations
NONE	squelch state and squelch value are not read out of the memory locations

**RST state*

MEMory

Example:

OUTPut:SQUelch:CONTrol NONE

. . :CONTrol?

Query of the source of squelch setting when reading memory locations

Parameters:

none

Result:

MEM, NONE

Example:

OUTPut : SQUelch : CONTrol? → MEM

. . . :THReshold
 [:UPPer] <numeric_value>|UP|DOWN|MINimum|MAXimum

Setting of squelch threshold

Parameters:

<numeric_value>	squelch threshold in dBuV
UP DOWN	increase decrease of squelch threshold by the value set with the command OUTPut:SQUelch:THReshold[:UPPer]:STEP[:INCRement].
MINimum MAXimum	setting the lowest/highest squelch threshold

**RST state:*

10 dBuV

Example:

OUTPut:SQUelch:THReshold 35 dBuV

. . . . ? [MINimum|MAXimum]

Query of squelch threshold

Parameters:

none	query of current squelch threshold
MINimum MAXimum	query of lowest/highest squelch threshold

Result:

Level tone reference value in dBuV

Example:

OUTPut:SQUelch:THReshold? -> 35

. :STEP
 [:INCRement] <numeric_value>|MINimum|MAXimum

Setting the stepwidth for the command OUTP:SQU:THR[:UPP] UP|DOWN

Parameters:

<numeric_value>	stepwidth of squelch threshold in dBuV
MINimum MAXimum	setting the smallest largest stepwidth

**RST state:*

1 dBuV

Example:

OUTP:SQU:THR:STEP 10 dBuV

. [:INCRement]? [MINimum|MAXimum]

Query of stepwidth

Parameters:

none	query of currently set stepwidth
MINimum MAXimum	query of smallest largest stepwidth

Result:

Stepwidth of squelch threshold in dB μ V

Example:

OUTP:SQU:THR:STEP? -> 10

:TONE

. [:STATe] <Boolean>

Switch on/off of level tone function. With level tone function switched on a tone is output depending on the level magnitude.

Parameters:

ON	level tone on
OFF	level tone off

**RST state:*

OFF

Example:

OUTPut:TONE ON

. [:STATe]?

Query of the TONE mode

Parameters:

none

Result:

1	level tone on
0	level tone off

Example:

OUTPut:TONE? -> 1

. . :CONTrol ONLY|WITHaf

It can be selected whether, in the TONE mode, only the level tone or also the AF is output via the audio channel.

Parameters:

WITHaf	level tone and AF is output.
ONLY	only level tone is output.

**RST state:*

ONLY

Example:

OUTPut:TONE:CONTrol ONLY

. . :CONTrol?

Query of whether, in the TONE mode, only the level tone or also the AF is output via the audio channel.

Parameters:

none

Result:

ONLY, WITH

Example:

OUTPut:TONE:CONTrol? -> ONLY

. . :THReshold <numeric_value>|UP|DOWN|MINimum|MAXimum

Setting the level tone reference threshold. Based on this value, the level scale is zoomed in the range -15 to +15 dB and the level magnitude is output as a tone (0 dB corresponds to approx. 400 Hz)

Parameters:

<numeric_value>	level tone reference threshold in dBuV
UP DOWN	increase decrease of level tone reference threshold by the value set in the OUTPut:TONE:THReshold:STEP[:INCRement] command.
MINimum MAXimum	setting the lowest/highest level tone reference threshold

**RST state:*

15 dBuV

Example:

OUTPut:TONE:THReshold 35 dBuV

. . . :THReshold? [MINimum|MAXimum]

Query of level tone reference threshold

Parameters:

none query of current level tone reference threshold
 MINimum|MAXimum query of lowest/highest level tone reference threshold

Result:

Level tone reference threshold in dBuV

Example:

OUTPut:TONE:THReshold? MIN -> 6

**. . . . :STEP
 [:INCRement] <numeric_value>|MINimum|MAXimum**

Setting the stepwidth for the OUTP:TONE:THR UP|DOWN command

Parameters:

<numeric_value> stepwidth for level tone reference threshold in dBuV
 MINimum|MAXimum setting the smallest/largest stepwidth

**RST state:*

1 dBuV

Example:

OUTP:TONE:THR:STEP 10 dBuV

. [:INCRement]? [MINimum|MAXimum]

Query of stepwidth

Parameters:

none query of currently set stepwidth
 MINimum|MAXimum query of smallest/largest stepwidth

Result:

Stepwidth for level tone reference threshold in dBuV

Example:

OUTP:TONE:THR:STEP? -> 10

4.5.13 ROUTE subsystem

ROUTE

. :CLOSE <channel_list>

Selection of an antenna. Prior to this the old antenna must be switched off with ROUTE:OPEN:ALL (see ROUTE:SELEct).

Error message:

If more than one antenna is to be selected an execution error -221, "Settings conflict" is generated.

Parameters:

<channel_list> allowed to contain only one number (0 to 99)

**RST state:*

@0

Example:

ROUTE:CLOSE (@23)

. :CLOSE? <channel_list>

Query of whether the respective antenna is selected

Parameters:

<channel_list> contains one value for each antenna number to be queried

Result:

0 for each non-selected antenna number

1 for each selected antenna number

Example:

ROUTE:CLOSE? (@2, 10:12, 23) -> 0,0,0,0,1

. . :STATE? [MINimum|MAXimum]

Query of selected antenna

Parameters:

none query of currently selected antenna

MINimum|MAXimum query of smallest/largest antenna number

Result:

Antenna number as <Definite Length Block>

Example:

ROUTE:CLOSE:STATE? -> #15(@23)

- . **OPEN**
- . . **:ALL**

Select no antenna (antenna number 0 is set)

Parameters:
none

**RST state:*
none since command is an event

Example:
ROUTE:OPEN:ALL

- . **:PATH**
- . . **:CATalog?**

Request of a list with currently defined antenna names
If the option EB200FS (Field Strength Measurement) is fitted, specific names are assigned to antenna numbers 1 to 5 (see example below).

Parameters:
none

Result:
One string for each antenna name, separated by comma
<name_string1>,<name_string2>,...
If no antenna name is defined, a zero string ("") is output.

Example:
ROUTE:PATH:CATalog? -> "HE200 HF", "HE200 20-200M", "HE200 .2-0.5G",
"HE200 .5-3GHZ", "GENERIC DIPOL", "ANT06", "ANT07",.....

- . . **[:DEFine] <path_name>, <channel_list>**

Assignment of an antenna name to the antenna number

Parameters:
<path_name> This is a <Character Data> with up to 13 characters which contains the antenna name. The path name may also be put in inverted commas to allow the use of blanks.
<channel_list> see ROUTe:CLOSe

**RST state:*
All names are maintained also after *RST.

Example:
ROUTE:PATH HE110, (@10)

. . . **[:DEFine]? <path_name>**

Query of antenna number associated with specified antenna name

Parameters:

<path_name> see ROUTe:PATH:DEFine

Error message:

If the <path_name> could not be found in the list of names, an execution error -292, "Referenced name does not exist" will be generated.

Result:

Antenna number as <Definite Length Block>

Example:

ROUTE:PATH? HE110 → #15(@10)

. . . **:DELeTe**

. . . . **:ALL**

Clears all antenna name to antenna number assignments.

Parameters:

none

**RST state:*

no action since command is only an event

Example:

ROUTE:PATH:DELeTe:ALL

. . . . **[:NAME] <path_name>**

Clears a particular antenna name to antenna number assignment

Parameter:

<path_name> see ROUTe:PATH:DEFine

Error message:

If the <path_name> could not be found in the list of names, an execution error -292, "Referenced name does not exist" will be generated.

**RST state:*

no action since command is only an event

Example:

ROUTE:PATH:DELeTe HE110

. SElect <channel_list>|UP|DOWN|MINimum|MAXimum

Equivalent to the combination:

ROUTE:OPEN:ALL

ROUTE:CLOSE <channel_list>

Parameters:

<channel_list>

allowed to contain only one number (0 to 99)

UP|DOWN

transition to next/previous antenna

MINimum|MAXimum

setting of antenna with smallest/largest number

**RST state:*

See ROUTE:CLOSE

Example:

ROUTE:SElect (@23)

4.5.14 SENSe Subsystem

[SENSe]

. :BANDwidth|BWIDth
. . [:RESolution] <numeric_value>|UP|DOWN|MINimum|MAXimum

Selection of bandwidth

Parameters:

<numeric_value>	value of bandwidth
UP DOWN	to next previous bandwidth
MINimum MAXimum	setting the narrowest widest bandwidth

**RST state:*

100 kHz or the nearest bandwidth

Example:

BANDwidth 2.4 kHz

. . [:RESolution]? [MINimum|MAXimum]

Query of current IF bandwidth

Parameters:

none	query of current bandwidth
MINimum MAXimum	query of narrowest widest bandwidth

Result:

IF bandwidth in Hz without unit specified

Example:

BANDwidth? -> 2400

. :DATA? [<data_handle>]

Query of the current measured values of active sensor functions.

When only the command `SENSe:DATA?` is used to query measured values, the measured values reported back may be as old as 200 ms. For display on the unit measured values are captured every 200 ms and put into a buffer.

In the event that current data are needed the command combination `INIT::SENSe:DATA?` is to be used. As response to this query the current measured value is reported back.

When a complete measurement is to be started, possibly by using a predefined measuring time, for instance the command combination `FREQ 98.5 MHZ::INIT::SENSe:DATA?` should be used. As a result, the measurement history is reset, ie the detectors are discharged, a measurement is started and the result is reported back when the measuring time has elapsed.

In order not to block remote-control communication during longer measuring times, the measured value should only be queried when the measurement has been completed and not right after starting.

The measured value thus obtained is stored in `MTRACe`, provided that the path to the result buffer `MTRACe` was enabled with command `TRACE:FEED:CONTRol MTRACe, ALWays`.

The unit may actively report the end of measurement (MEASUring bit in operation status register becomes inactive) via SRQ if the status register has been configured accordingly (see also "Status reporting system" on page 127).

Note:

For this command the keyword `SENSe` must not be omitted as `DATA?` can be mixed up with the subsystem `TRACe/DATA`.

Parameters:

none	output of the measured values of all active sensor functions; if no function is switched on, an error -221, "Settings Conflict" will be generated
"[SENSe:]FREQuency:OFFSet"	output of offset value or error -221, "Settings Conflict"
"[SENSe:]VOLTage:AC"	output of level value or error -221, "Settings Conflict"
"[SENSe:]FSTRength"	output of measured field strength value or error -221, "Settings Conflict"

Note:

The sensor function `FSTRength` will only provide results if the SW option `EB200Fs` is fitted. Also see Annex H.

Result:

Level in dB μ V, offset in Hz, field strength in dB μ V/m

The output format will be generated with the command `FORMat:DATA` according to the setting:

<code>ASCIi</code>	normal ASCII output
<code>PACKed</code>	<Definite Length Block>: level in 1/10 dB μ V (2 bytes), offset in Hz (4 bytes) field strength in 1/10 dB μ V/m (2 byte)

Examples:

`SENSe:DATA? -> 23.4, -2500`

`SENSe:DATA? "VOLT:AC" -> 23.4`

`SENSe:DATA? "FREQuency:OFFSet" -> -2500`

`SENSe:DATA? "FSTRength" -> 45.4`

. :DEModulation AM|FM| PULSe|A1|CW|LSB|USB|IQ|A0

Switchover of type of demodulation

Note:

For SSB demodulation (CW, LSB and USB,) the frequency stepwidth is set to 1 Hz..

Error message:

If the set bandwidth exceeds 9 kHz at CW, LSB and USB, an error -221, "Settings conflict" will be generated if one of the SSB operating modes is to be switched on.

Parameters:

FM	switch on FM demodulator
AM	switch on AM demodulator
PULSe	switch on pulse demodulator
CW or A1	switch on SSB demodulator 1 kHz beat
USB	switch on SSB demodulator upper sideband
LSB	switch on SSB demodulator lower sideband
IQ or A0	switch on IQ demodulator

***RST state:**

FM

Example:

DEModulation FM

. :DEModulation?

Query of demodulation type

Parameters:

none

Result:

FM, AM, PULSe, CW, USB, LSB, IQ

Example:

DEModulation? -> FM

- . **:DETector**
- . . **[:FUNCTION] POSitive|PAVerage|FAST**

Switching over the level-measuring process

Parameters:

POSitive	measuring the peak value (PEAK)
PAVerage	measuring the average value (AVG)
FAST	measuring the current value (FAST)

**RST state:*

PAVerage

Example:

DETector POSitive

- . . **[FUNCTION]?**

Query of the current set level-measuring process

Parameters:

none

Result:

POS, PAV or FAST

Example:

DETector? → POS

. :DSCan

. . :COUNT <numeric_value>|MINimum|MAXimum|INFINITY

Statement of number of DSCan runs

Parameters:

<numeric_value>	number of runs
MINimum MAXimum	minimum/maximum number
INFINITY	infinite number

**RST state:*

INFINITY

Example:

DSCan:COUNT 100

. . :COUNT? [MINimum|MAXimum]

Query of number of DSCan runs

Parameters:

none	query of current number of runs
MINimum MAXimum	query of minimum/maximum number of runs

Result:

Number of runs, for an infinite number 9.9E37 is output.

Example:

DSCan:COUNT? -> 100

. :FREQuency

. . :AFC <Boolean>

Switch on/off the AFC function.

Parameters:

ON	AFC function on
OFF	AFC function off

**RST state:*

OFF

Example:

SENSe:FREQuency:AFC ON

. . :AFC?

Query of AFC function

Parameters:

none

Result:

AFC function on	1
AFC function off	0

Example:

SENSe:FREQuency:AFC? -> 1

. . [:CW|FIXed] <numeric_value>|UP|DOWN|MINimum|MAXimum

Setting of receiver frequency

Parameters:

<numeric_value>	frequency value
UP DOWN	increase decrease of receiver frequency by the value set in the command SENS:FREQuency[:CW FIX]:STEP[:INCRement]

MINimum MAXimum	setting the lowest highest receiver frequency
-----------------	---

**RST state:*

98.5 MHz

Example:

FREQuency 98.5 MHz

. . [CW|FIXed]? [MINimum|MAXimum]

Query of receiver frequency

Parameters:

none	query of current receiver frequency
MINimum MAXimum	query of lowest highest receiver frequency

Result:

Frequency value in Hz

Example:

FREQuency? -> 98500000

. . :DSCan

If the START and/or STOP frequency is changed then CENTER or SPAN is adjusted.
 If CENTER or SPAN is changed, then the START or STOP frequency is adjusted.

Either CENTER and SPAN or START and STOP frequency can be changed in a command at the same time. Other parameter combinations will be rejected.

. . . :CENTER <numeric_value>|MINimum|MAXimum

Sets the center frequency of Digiscan.
 Corrects START and STOP frequency.

Parameter:

<numeric-value>	frequency value
MINimum MAXimum	setting min/max center frequency

**RST state:*

97.5 MHz

Example:

FREQuency : DSCan : CENTER 118 MHz

. . . :CENTER? [MINimum|MAXimum]

Query of the center frequency of Digiscan

Parameters:

none	query of the current center frequency
MINimum MAXimum	query of the min/max center frequency

Result:

Frequency value in Hz

Example:

FREQuency : DSCan : CENTER? → 118000000

. . . :MARKer <numeric_value>|MINimum|MAXimum

Sets the marker frequency of Digiscan

Parameters:

<numeric_value>	frequency value
MINimum MAXimum	setting min/max marker frequency

**RST state*

98.5 MHz

Example:

FREQuency : DSCan : MARKer 120 MHz

. . . :MARKer? [MINimum|MAXimum]

Query of the marker frequency of Digiscan

Parameters:

none	query of the current marker frequency
MINimum MAXimum	query of min/max marker frequency

Result:

Frequency value in Hz

Example:

FREQuency : DSCan : MARKer? -> 120000000

. . . :RESolution:AUTO<Boolean>

Setting BW ZOOM on and off. When the BW ZOOM is set on in DSCAN, the start and stop frequency as well as span and center frequency are coupled (see 3.18.3 D-SCAN (OPTION)):

Parameters:

ON	BW ZOOM mode on
OFF	BW ZOOM mode off

**RST state:*

OFF

Example:

FREQuency:DSCan:RESolution:AUTO ON

. . . :RESolution:AUTO?

Query of BW ZOOM mode.

Parameter:
none

Result:
 BW ZOOM mode on 1
 BW ZOOM mode off 0

Example:
 FREQuency:DSCan:RESolution:AUTO -> 1

. . . :SPAN <numeric_value>|MINimum|MAXimum

Sets the display range of Digiscan
 Corrects START and STOP frequency

Parameters:
 <numeric_value> frequency value
 MINimum | MAXimum setting min/max display range

**RST state:*
 25 MHz

Example:
 FREQuency : DSCan : SPAN 10 MHz

. . . :SPAN? [MINimum|MAXimum]

Query of the display range of Digiscan

Parameters:
 none query of the current display range
 MINimum | MAXimum query of min/max display range

Result:
 frequency value in Hz

Example:
 FREQuency : DSCan : SPAN? -> 10000000

. . . :SPEed LOW|NORMa1|HIGH|MTIME

Selection of DSCan speed.

The digital scan cannot be slowed down while it is running. Generated data can therefore be lost if they are not collected fast enough at the remote control interface. The maximum data throughput at the remote control interface can be fixed indirectly by setting the DSCan speed.

The NORMa1 setting corresponds to a medium speed at which with all probability all the results can be transferred to an application via the Ethernet interface with the aid of TCP. This is the standard setting after power-up of the unit and corresponds to the DSCan speed in firmware versions up to V02.22.

The LOW setting corresponds to a speed which is about 10 times less than that of the NORMa1 setting. The maximum data rate is limited to 6 Kbyte/sec. This setting enables the transfer of all data via the RS232 PPP interface with the aid of UDP.

The HIGH setting gives the highest speed. The data rate can be as much as 260 Kbyte/sec. The results can be transferred to an application only via the Ethernet interface with the aid of UDP.

In position MTIME it is not the hardware-supported sweep mechanism of the DSCAN which is used but incremental frequency stepping as in F-SCAN. This permits level measurement to be carried out for each channel in a specific measuring time. This mode is particularly suitable when it comes to measure impulse noise and simultaneously indicate the spectrum on the display. The speed depends on the measuring time.

Parameter:

LOW	slow speed
NORMa1	medium speed (default after power-on)
HIGH	fastest speed
MTIME	speed depends on measuring time

**RST state:*

NORMa1

Example:

FREQuency:DSCan:SPEed NORMa1

. . . :SPEed?

Query of the selected DSCan speed

Parameter:

None

Results:

LOW , NORM, HIGH, MTIM

Example:

FREQuency:DSCan:SPEed? → NORM

. . . :START <numeric_value>|MINimum|MAXimum

Sets the start frequency of Digiscan

Parameters:

<numeric_value>	frequency value
MINimum MAXimum	setting min/max start frequency

**RST state:*

85 MHz

Example:

FREQuency : DSCan : START 118 MHz

. . . :START? [MINimum|MAXimum]

Query of the start frequency of Digiscan

Parameters:

none	query of the current start frequency
MINimum MAXimum	query of min/max start frequency

Result:

frequency in Hz

Example:

FREQuency : DSCan : START? → 118000000

. . . :STOP <numeric_value>|MINimum|MAXimum

Sets the stop frequency of Digiscan

Parameters:

<numeric_value>	frequency value
MINimum MAXimum	setting min/max stop frequency

**RST state*

110 MHz

Example:

FREQuency : DSCan : STOP 136 MHz

. . . :STOP? [MINimum|MAXimum]

Query of the stop frequency of Digiscan

Parameters:

none	query of the current stop frequency
MINimum MAXimum	query of min/max stop frequency

Result:

frequency in Hz

Example:

FREQuency : DSCan : STOP? → 136000000

. . :MODE CW|FIXed|SWEep|MSCan|DSCan|FASTlevcw|LIST

Changing the operating mode of the receiver.

Parameters:

CW FIXed	receiver monitors a frequency (CW and FIXed have equal meanings)
SWEep	receiver is in frequency-scan mode (see SENSe : SWEep)
MSCan	receiver is in memory-scan mode (see SENSe : MSCan)
DSCan	receiver is in Digi-scan mode with data set
FASTlevcw	receiver is in Fastlevcw mode (fast triggered level measurement on one frequency)
LIST	receiver is in List mode (fast triggered level measurement on frequencies of a frequency list)

Remark:

The receiver stays on the CW frequency until it starts scanning!
 The Digi-scan mode can be set only if the corresponding software EB200DS option is installed (this software option is only available from V2.00 on).

Remarks referring to FASTlevcw and LIST mode:

The FASTlevcw and LIST modes can only be set after the EB200CM (Coverage Measurement) option has been enabled. (This SW option is available from V2.50 onwards.)
 When changing to mode FASTlevcw or LIST, display and operation will both be disabled automatically since in these two modes there is no useful indication available. After changing to a different mode such as eg CW the display must be re-activated by using command DISPlay:ENABle.
 In LIST mode, the continuous self-test of the unit is switched off after activation with command INIT and only switched on again after deactivation with command ABORt. See also Annex G (Coverage Measurement).

**RST state:*

CW

Example:

FREQuency : MODE SWEep

. . :MODE?

Query of receiver operating mode

Parameters:

none

Result:

CW, SWE, MSC, DSC, FAST, LIST

Example:

FREQuency:MODE? -> SWE

. . :SPAN<numeric_value>|UP|DOWN |MINimum|MAXimum

Selection of frequency range with option IF panorama.

The following ranges are available in addition to the IF bandwidths: 25, 50, 100, 200, 500, 1000 kHz. If a frequency range is entered it will be brought up to the next higher range.

Parameters:

<numeric_value>	frequency range
UP DOWN	taking the range after before the current bandwidth
MINimum MAXimum	setting the minimum maximum frequency range

**RST state:*

1000 kHz

Example:

FREQuency:SPAN 25 kHz

. . :SPAN? [MINimum|MAXimum]

Query of frequency range with option IF panorama.

Parameters:

none	query of current frequency range
MINimum MAXimum	query of minimum maximum frequency range

Result:

Frequency value Hz

Example:

FREQuency:SPAN? → 25000

. . :START <numeric_value>|MINimum|MAXimum

Setting of start frequency of a frequency scan

Parameters:

<numeric_value>	frequency
MINimum MAXimum	setting the lowest highest start frequency

**RST state:*

20 MHz

Example:

FREQuency:START 118 MHz

. . . :START? [MINimum|MAXimum]

Query of start frequency of a frequency scan

Parameters:

none	query of current start frequency
MINimum MAXimum	query of lowest highest start frequency

Result:

Frequency in Hz

Example:

FREQuency:START? -> 118000000

**. . . :STEP
. . . . [:INCRement] <numeric_value>|MINimum|MAXimum**

Setting the stepwidth for the command `SENSe:FREQuency[:CW|FIXed] UP|DOWN`

Note:

For SSB demodulation (CW, LSB and USB), the frequency stepwidth will be set to 1 Hz.

Parameters:

<numeric_value>	frequency stepwidth
MINimum MAXimum	setting the smallest largest stepwidth

**RST state:*

1 kHz

Example:

FREQuency:STEP 25 kHz

. . . . [:INCRement]? [MINimum|MAXimum]

Query of stepwidth

Parameters:

none	query of currently set stepwidth
MINimum MAXimum	query of smallest largest stepwidth

Result:

Frequency stepwidth in Hz

Example:

FREQuency:STEP? -> 25000

. . :STOP <numeric_value>|MINimum|MAXimum

Setting the stop frequency of a frequency scan

Parameters:

<numeric_value>	frequency
MINimum MAXimum	setting the lowest highest stop frequency

**RST state:*

650 MHz

Example:

FREQuency:STOP 136 MHz

. . :STOP? [MINimum|MAXimum]

Query of a stop frequency of a frequency scan

Parameters:

none	query of current stop frequency
MINimum MAXimum	query of lowest highest stop frequency

Result:

Frequency in Hz

Example:

FREQuency:STOP? -> 136000000

. :FUNCtion

If the sensor function(s) is (are) changed, the trace data set `MTRACE` is always deleted.

. . :CONCurent <Boolean>

Determines whether several sensor functions can at the same time be switched or not. If `CONCurent = OFF`, the command `SENSe:FUNcTion[:ON]` has the effect of a 1-out-of-n selection (one is switched on, the previously activated is automatically switched off). If `CONCurent = ON`, the command `SENSe:FUNcTion[:ON]` switches the corresponding function on, while all the other functions remain unchanged. If `CONCurent` is switched from `ON` to `OFF`, the function `"VOLTage:AC"` is switched on and all other functions are switched off.

Parameters:

<code>ON</code>	<code>CONCurent on</code>
<code>OFF</code>	<code>CONCurent off</code>

**RST state:*

`ON`

Example:

`FUNcTion:CONCurent ON`

. . :CONCurent?

Query of several sensor functions that, at the same time, can be switched or not.

Parameters:

`none`

Result:

<code>CONCurent switched on</code>	<code>1</code>
<code>CONCurent switched off</code>	<code>0</code>

Example:

`FUNcTion:CONCurent? -> 1`

. . :OFF <sensor_function> {,<sensor_function>}

Switch off of one or several sensor functions.

Parameters:

see `SENSe:FUNcTion[:ON]`

**RST state:*

`"FREQ:OFFS"`

Example:

`FUNcTion:OFF "FREQ:OFFS"`

. . :OFF?

Query of the sensor functions being switched off

Parameters:
none

Result:
List of the sensor functions being switched off. For strings see `SENSe:FUNction[:ON]`

Example:
`FUNction:OFF? -> "FREQ:OFFS"`

. . . :COUNT?

Query of the number of sensor functions being inactive

Parameters:
none

Result:
Number of sensor functions being inactive

Example:
`FUNction:OFF:COUNT? -> 2`

. . [:ON] <sensor_function> {,<sensor_function>}

Switch on of one or several sensor functions.

Error message:

If `CONCurent = OFF`, an error -108, "Parameter not allowed" will be generated for two or several parameters.

Parameters:
<sensor_function> is one of the following strings:

"VOLTage:AC"	switch on level measurement
"FREQuency:OFFSet"	switch on offset measurement
"FSTRength"	switch on field strength measurement

Note:

The sensor function `FSTRength` will only provide results if the SW option `EB200FS` is fitted. Also see Annex H.

**RST state:*
"VOLTage:AC"

Example:
`FUNction "VOLT:AC", "FREQ:OFFS"`

. . . [:ON]?

Query of sensor functions being switched on

Parameters:

none

Result:

List of sensor functions switched on. If no function is active, a zero string ("") is output. The list has a specific order:

1. level measurement function
2. offset measurement function
3. field strength measurement function

The following strings are to be expected:

"VOLT:AC"	level measurement switched on
"FREQ:OFFS"	offset measurement switched on
"FSTR"	field strength measurement switched on

Example:

FUNction? -> "VOLT:AC", "FREQ:OFFS"

. . . :COUNT?

Query of the number of sensor functions being active

Parameters:

none

Result:

Number of sensor functions being active

Example:

FUNction:Count? -> 2

. :GCONtrol

. . [:FIXed|MGC] <numeric_value>|UP|DOWN|MINimum|MAXimum

Setting of MGC value

Parameters:

<numeric_value>	gain control factor in dB μ V -30 dB μ V = no gain control -> maximum sensitivity 110 dB μ V = maximum gain control -> minimum sensitivity
UP DOWN	increase decrease of the MGC value by the value set in the command
MINimum MAXimum	SENSe:GCONtrol[:FIXed MGC]:STEP[:INCRement]. setting the smallest largest MGC value

*RST state:

50 dBuV

Example:

GCONtrol 50

. . [:FIXed|MGC]? [MINimum|MAXimum]

Query of the MGC value

Parameters:

none	query of current MGC value
MINimum MAXimum	query of smallest largest MGC value

Result:

Gain control

Example:

GCONtrol? -> 50

. . . :STEP

. . . . [:INCRement] <numeric_value>|MINimum|MAXimum

Setting the stepwidth for the command SENSe:GCONtrol[:FIXed|MGC] UP|DOWN

Parameters:

<numeric_value>	MGC stepwidth
MINimum MAXimum	smallest largest stepwidth

*RST state:

1 dB

Example:

GCONtrol:STEP 10

. . . . [:INCRement]? [MINimum|MAXimum]

Query of the MGC stepwidth

Parameters:

none	query of currently set stepwidth
MINimum MAXimum	query of smallest largest stepwidth

Result:

MGC stepwidth in dB

Example:

GCONtrol:STEP? -> 10

. . :MODE FIXed|MGC|AUTO|AGC

Type of gain control

Parameters:

FIXed MGC	control is determined by MGC value
AUTO AGC	control is automatically generated (AGC)

**RST state:*

AUTO

Example:

GCONtrol:MODE AUTO

. . :MODE?

Query of type of gain control

Parameters:

none

Result:

FIX, AUTO	see above
-----------	-----------

Example:

GCONtrol:MODE? -> AUTO

. :MSCan

The MSCan system controls the frequency function of the device, provided the memory scan has been activated by `SENSe:FREQuency:MODE MSCan`. Each scan is started by `INITiate[:IMMEDIATE]`. The memory locations are placed in the MEMory subsystem and are set for query during the scan.

. . :CHANnel <name>

Setting of current memory location.

The memory locations are addressed by the text (see "Parameters" on page 9) MEM0 to MEM999 (memory location 0 to memory location 999) and the next free memory location by ACTUAL .

During the memory scan, this command is not permitted.

Parameters:

<name> MEM0 to MEM999 | NEXT

*RST state:

MEM0

Example:

MSCan:CHANnel MEM357

. . :CHANel?

Output of current memory location.

Parameters:

none

Result:

Number of current memory location.

Example:

MSCan:CHANnel? → 357

. . :CONTRol

. . . :[ON]<control_function> {,<control_function>}

Command for switch-on of the 'STOP:SIGNal' functions .

With 'STOP:SIGNal' the disappearance of the signal during the dwell time causes the dwell time to be aborted. The hold time after the disappearance of the signal is set with `SENSe:MSCan:HOLD:TIME`.

Parameters:

<control_function> is the following string:

'STOP:SIGNal' switches the signal-controlled dwell time on

*RST state

After *RST there is no control function running

Example:

MSCan:CONTRol 'STOP:SIG'

. . . [:ON]?

Query of scan-control mechanism that is switched on.

Parameters:

none

Result:

A list of the scan-control mechanisms that are switched on is output. If there is nothing switched on then a zero string ("") is output.

Following strings can be expected:

" "	no mechanism switched on
"STOP:SIGN"	signal-controlled dwell time is switched on

Example:

MSCan:CONTrol?→"STOP:SIGN"

. . . :OFF <control_function> {,<control_function>}

Switches off one or more scan-control mechanisms

Parameters:

see SENSe:MSCan:CONTrol [:ON]

**RST state*

after *RST there is no control function enabled

Example:

MSCan:CONTrol:OFF "STOP:SIGN"

. . . :OFF?

Query of scan-control mechanisms that are switched off

Parameters:

none

Result:

A list of the scan-control mechanisms that are switched off is output. For strings see SENSe:MSCan:CONTrol[:ON].

Example:

MSCan:CONTrol:OFF?→"STOP:SIGN"

. . :COUNT <numeric_value>|MINimum|MAXimum|INFINITY

Information about the number of MScans

Parameters:

<numeric_value>	number of scans
MINimum MAXimum	minimum maximum number
INFINITY	infinite number

**RST state:*

INFINITY

Example:

MScan:COUNT 100

. . :COUNT? [MINimum|MAXimum]

Query of number of MScans

Parameters:

none	query of current number of scans
MINimum MAXimum	query of minimum maximum number of scans

Result:

Number of scans; 9.9E37 is output for an infinite number

Example:

MScan:COUNT? -> 100

. . :DIRection UP|DOWN

Sets scan direction

Parameters:

UP	scans in direction of descending memory numbers
DOWN	scans in direction of ascending memory numbers

**RST state*

UP

Example:

MScan:DIRection DOWN

. . :DIRection?

Query of scan direction

Parameters:
none

Result:
UP, DOWN

Example:
MScan:DIRection?→DOWN

. . :DWELl <numeric_value>|MINimum|MAXimum|INFINITY

Setting the dwell time with the hold criterion fulfilled (T-DWELL in MSCAN-CONFIG menu).

Note:

According to the SCPI standard, this command is used to set the dwell time per scan step, ie the time required by a step. This definition is met in EB200, if the squelch is switched off. The hold criterion is then fulfilled for each step.

Parameters:

<numeric_value>	dwell time in seconds
MINimum MAXimum	lowest highest dwell time
INFINITY	infinite dwell time

**RST state:*
0.5 s

Example:
SWEEp:DWELl 10 ms

. . :DWELl? [MINimum|MAXimum]

Query of dwell time

Parameters:

none	query of current dwell time
MINimum MAXimum	query of lowest highest dwell time

Result:
Dwell time in seconds; 9.9E37 is output for an infinite number

Example:
MScan:DWELl? 0.010

. . . :HOLD
. . . :TIME <numeric_value>|MINimum|MAXimum

Setting the hold time during signal-controlled scan continuation (T_NOSIG in MSCAN-CONFIG menu). If the signal disappears during the dwell time, the hold time is started. After completion of the hold time, the scan is continued with the next frequency even if the dwell time has not yet been completed. If the signal during the hold time exceeds the squelch threshold, the hold time is reset and the end of the dwell time or the renewed disappearance of the signal is awaited. The hold time is only important if the control function "STOP:SIGNal" (see SENSE:MSCan:CONTRol) is switched on.

Parameters:

<numeric_value>	hold time in seconds
MINimum MAXimum	lowest highest hold time

**RST state:*

0 s

Example:

SWEep:HOLD:TIME 10 ms

. . . :TIME? [MINimum|MAXimum]

Query of hold time

Parameters:

none	query of current hold time
MINimum MAXimum	query of lowest highest hold time

Result:

Hold time in seconds

Example:

MSCan:HOLD:TIME? 0.010

. :LIST

Within EB200 the LIST subsystem is used to define a list of frequencies. Provided that the EB200CM SW option is fitted, in FREQuency:MODE LIST mode triggered level measurements can be carried out on up to 50 frequencies.

. . :FREQuency <numeric_value>, <numeric_value>,

Input of list of frequencies on which levels are to be measured in LIST mode.

Parameter:

<numeric_value> frequency value

Note:

The number of possible frequency values can be queried by using command SENSe:LIST:FREQuency:POINts?.

**RST state:*

935200000, 935400000, 935600000

50 frequencies altogether in increments of 10 kHz

Example:

LIST:FREQuency 935.8 MHz, 936.0 MHz, 936.2 MHz

. . LIST:FREQuency?

Query of list of frequencies on which levels are to be measured in LIST mode

Parameters:

none

Result:

<numeric_value>, <numeric_value>, ...

Example:

LIST:FREQuency? -> 935800000, 936000000, 936200000

. . LIST:FREQuency:POINts? MINimum|MAXimum

Query of the number of frequencies covered by command LIST:FREQuency

Parameters:

none

query of current number of frequencies

MINimum|MAXimum

query of minimum/maximum number of frequencies

Example:

LIST:FREQuency:POINts? MAX -> 50

. :ROSCillator

Control of reference oscillator

. . :EXTernal

. . . :FREQUENCY?

Query of given external reference frequency

Parameters:

none

Result:

10000000

Example:

ROSCillator:EXTernal:FREQUENCY? -> 10000000

. . [:INTernal]

. . . :FREQUENCY?

Query of internal reference frequency

Parameters:

none

Result:

10000000

Example:

ROSCillator:FREQUENCY? -> 10000000

. . :SOURce INTernal|EXTernal

Setting whether external or internal reference frequency is to be used

Parameters:

INTernal

internal reference oscillator

EXTernal

external reference oscillator

**RST state:*

INTernal

Example:

ROSCillator:SOURce EXTernal

. . :SOURce?

Query of reference oscillator to be used

Parameters:

none

Result:

INT

internal reference oscillator

EXT

external reference oscillator

Example:

ROSCillator:SOURce? -> EXT

. :SWEep

The SWEEp system controls the frequency function of the device if the frequency scan has been activated by the SENSE:FREQUENCY:MODE SWEEp command. Each scan is initiated by INITiate[:IMMediate].

**. . :CONTRol
. . . :[ON] <control_function> {,<control_function>}**

Command for switch-on of the STOP:SIGNal functions.
With "STOP:SIGNal" the disappearance of the signal during the dwell time causes the dwell time to be aborted. The hold time after the disappearance of the signal is set with SENSE:SWEEp:HOLD:TIME.

Parameters:

<control_function> is one of the following strings:
"STOP:SIGNal" switch-on signal-controlled scan continuation

**RST state:*
After *RST no control function is switched on.

Example:
SWEEp:CONTRol "STOP:SIGN"

. . . [:ON]?

Query of switched-on scan-control functions.

Parameters:
none

Result:
List of switched-off control functions. If no function is active, a zero string ("") is output.

The following strings are to be expected:
"STOP:SIGN" signal-controlled scan continuation switched on
"" zero string : none of the two functions is active

Example:
SWEEp:CONTRol? -> "STOP:SIGN"

. . . :OFF <control_function>{,<control_function>}

Switch-off of one or several scan-control functions.

Parameters:

see SENSE:SWEEp:CONTrol [:ON]

**RST state:*

after *RST there is no control function running

Example:

SWEEp:CONTrol:OFF "STOP:SIGN"

. . . :OFF ?

Query of switched-off scan-control functions.

Parameters:

none

Result:

List of switched-off control functions. Strings see SENSE:SWEEp:CONTrol [:ON]

Example:

SWEEp:CONTrol:OFF? ->"STOP:SIGN"

. . :COUNT <numeric_value>|MINimum|MAXimum|INFINITY

Information about the number of sweeps

Parameters:

<numeric_value>	number of sweeps
MINimum MAXimum	minimum maximum number
INFINITY	infinite number

**RST state:*

INFINITY

Example:

SWEEp:COUNT 100

. . :COUNT? [MINimum|MAXimum]

Query of number of sweeps

Parameters:

none	query of current number of sweeps
MINimum MAXimum	query of minimum maximum sweeps

Result:

Number of sweeps; 9.9E37 is output for an infinite number

Example:

SWEep:COUNT? -> 100

. . :DIRection UP|DOWN

Setting the scan direction

Parameters:

UP	scan with increasing frequency
DOWN	scan with decreasing frequency

**RST state:*

UP

Example:

SWEep:DIRection DOWN

. . :DIRection?

Query of scan direction

Parameters:

none

Result:

UP, DOWN

Example:

SWEep:DIRection? -> DOWN

. . :DWEI <numeric_value>|MINimum|MAXimum|INFinity

Setting the dwell time with the hold criterion fulfilled (T-DWELL in FSCAN-CONFIG menu).

Note:

According to the SCPI standard, this command is used to set the dwell time per scan step, ie the time required by a step. This definition is met in EB200, if the squelch is switched off. The hold criterion is then fulfilled for each step.

Parameters:

<numeric_value>	dwell time in seconds
MINimum MAXimum	lowest highest dwell time
INFinity	infinite dwell time

***RST state:**

0.5 s

Example:

SWEep:DWEI 10 ms

. . :DWEI? [MINimum|MAXimum]

Query of dwell time with hold criterion fulfilled

Parameters:

none	query of current dwell time
MINimum MAXimum	query of lowest highest dwell time

Result:

Dwell time in seconds; ; 9.9E37 is output for an infinite number.

Example:

SWEep:DWEI? 0.010

. . :HOLD

. . . :TIME <numeric_value>|MINimum|MAXimum

Setting the hold time during signal-controlled scan continuation (T_NOSIG in FSCAN-CONFIG menu). If the signal disappears during the dwell time, the hold time is started. After completion of the hold time, the scan is continued with the next frequency even if the dwell time has not yet been completed. If the signal during the hold time exceeds the squelch threshold, the hold time is reset and the end of the dwell time or the renewed disappearance of the signal is awaited. The hold time is only important if the control function "STOP:SIGNal" (see SENSe:SWEep:CONTRol) is switched on.

Parameters:

<numeric_value>	hold time in seconds
MINimum MAXimum	lowest highest hold time

***RST state:**

0 s

Example:

SWEep:HOLD:TIME 10 ms

. . . :TIME? [MINimum|MAXimum]

Query of hold time during signal-controlled scan continuation

Parameters:

none	query of current hold time
MINimum MAXimum	query of lowest highest hold time

Result:

Hold time in seconds

Example:

SWEEP:HOLD:TIME? 0.010

. . :STEP<numeric_value>|MINimum|MAXimum

Setting the frequency stepwidth for the frequency scan

Parameters:

<numeric_value>	frequency value
MINimum MAXimum	setting the smallest/biggest frequency stepwidth

**RST state:*

10 kHz

Example:

SWEEP:STEP 25 kHz

. . :STEP? [MINimum|MAXimum]

Query of frequency stepwidth of a frequency scan

Parameters:

none	query of current frequency stepwidth
MINimum MAXimum	query of smallest largest frequency stepwidth

Result:

Stepwidth in Hz

Example:

SWEEP:STEP? -> 25000

. . . :SUPPress

Insert current frequency into suppress list. The range is obtained from the bandwidth according to the following formulae:

$$SSTARTn = SENSn: FREQ - SENSn: BAND / 2$$

$$SSTOPn = SENSn: FREQ + SENSn: BAND / 2$$

The frequency pair is inserted into an empty space of the trace. Free spaces (gaps) are characterized by a frequency pair with the values 0.0.

Error message:

If the corresponding suppress trace has no free space, an error -223 "Too much data" is generated.

Note:

Suppress list 1 to 100 corresponds to 0 to 99 on front panel

Parameters:

none

**RST state:*

none, as command is an event

Example:

```
SWEEp: SUPPress
```

. . . :SORT

Sort and condense suppress list. The frequency pairs are sorted to an ascending order of the start frequency. Overlapping is eliminated by extending the frequency pair. The other frequency pair is then deleted. Gaps within the suppress list are put to the end of the list.

Parameters:

none

**RST state:*

none, as command is an event

Example:

```
SWEEp: SUPPress: SORT
```

- . :VOLTage:AC:RANGe
- . . [:UPPer]<numeric_value>UP|DOWN|MINimum|MAXimum

This command is used in the DSCAN mode to set the reference level. In order to avoid overdriving of the receiver, the reference level is set to the highest expected positive signal level.

Parameters:

<numeric_value>	reference level in dB μ V
UP DOWN	increase decrease of the reference level by the value that was set by command VOLTage:AC:RANGe:STEP[:INCRement]
MINimum MAXimum	minimum maximum reference level

**RST state:*

70 dB μ V

Example:

VOLTage:AC:RANGe 90 dB μ V

- . . . :RANGe? [MINimum|MAXimum]

Query of reference level

Parameters:

none	query of current reference level
MINimum MAXimum	query of lowest highest reference level

Result:

Reference level in dB μ V.

Example:

VOLTage:AC:RANGe? -> 90

- :STEP
- [:INCRement] <numeric_value>|MINimum|MAXimum

Setting the stepwidth for the command VOLTage:AC:RANGe UP|DOWN

Parameters:

<numeric_value>	stepwidth of reference level in dB μ V
MINimum MAXimum	setting the minimum maximum stepwidth

**RST state:*

1 dB μ V

Example:

VOLTage:AC:RANGe:STEP 10 dB μ V

. [:INCRement]? [MINimum|MAXimum]

Query of stepwidth

Parameters:

none

query of current stepwidth

MINimum | MAXimum

query of minimum|maximum stepwidth

Result:

Stepwidth of reference level in dBuV

Example:

VOLTage:AC:RANGe:STEP? -> 10

4.5.15 STATus subsystem

The following STATus register commands are possible according to SCPI standard:

```

STATus
.  :OPERation
.  .  :CONDition?
.  .  :ENABle <numeric_value>
.  .  :ENABle?
.  .  [:EVENT]?
.  .  :NTRansition <numeric_value>
.  .  :NTRansition?
.  .  :PTRansition <numeric_value>
.  .  :PTRansition?
.  .  :SWEeping
.  .  .  :CONDition?
.  .  .  :ENABle <numeric_value>
.  .  .  :ENABle?
.  .  .  [:EVENT]?
.  .  .  :NTRansition <numeric_value>
.  .  .  :NTRansition?
.  .  .  :PTRansition <numeric_value>
.  .  .  :PTRansition?

.  :QUEStionable
.  .  :CONDition?
.  .  :ENABle <numeric_value>
.  .  :ENABle?
.  .  [:EVENT]?
.  .  :NTRansition <numeric_value>
.  .  :NTRansition?
.  .  :PTRansition <numeric_value>
.  .  :PTRansition?

```

extended STATus register commands:

```

STATus
.  :EXTension
.  .  :CONDition?
.  .  :ENABle <numeric_value>
.  .  :ENABle?
.  .  [:EVENT]?
.  .  :NTRansition <numeric_value>
.  .  :NTRansition?
.  .  :PTRansition <numeric_value>
.  .  :PTRansition?

```

```

STATus
.  :TRACe
.  .  :CONDition?
.  .  :ENABle <numeric_value>
.  .  :ENABle?
.  .  [:EVENT]?
.  .  :NTRansition <numeric_value>
.  .  :NTRansition?
.  .  :PTRansition <numeric_value>
.  .  :PTRansition?

```

Exemplifying all STATus register commands, for example the STATus:OPERation:SWEEPing register, the commands of the STATus:OPERation register are explained as follows.

STATus

. OPERation . . :CONDition?

Query of the condition section of the OPERation status register

Parameters:
none

Result:

Depending on the setting by the FORMat:SREGister command, the contents of the register is transferred as a decimal, binary or hexadecimal value in the ASCII code.

Example:

STATus:OPERation:CONDition? -> #H0008

. . :ENABle <numeric_value>

Setting the enable section of the OPERation status register

Parameters:
<numeric_value> value of the enable section (0..65535 or #H0000..#HFFFF
or #B0..#B1111111111111111)

**RST state:*
will not be changed by *RST

Example:

STATus:OPERation:ENABle #H0008

. . :ENABle?

Query of the enable section of the OPERation status register

Parameters:
none

Result:

Depending on the setting by the FORMat:SREGister command, the contents of the register is transferred in decimal, binary or hexadecimal form in the ASCII code.

Example:

STATus:OPERation:ENABle? -> #H0008

. . [:EVENT]?

Query of the event section of the OPERation status register

Parameters:

none

Result:

Depending on the setting by the FORMat:SREGister command, the contents of the register is transferred as a decimal, binary or hexadecimal value in ASCII code.

Example:

```
STATus:OPERation? -> #H0008
```

. . :NTRansition <numeric_value>

Setting the negative transition filter of the OPERation status register

Parameters:

<numeric_value> value of the NTRansition section (0..65535 or
#H0000..#HFFFF or #B0..#B1111111111111111)

**RST state:*

will not be changed by *RST

Example:

```
STATus:OPERation:NTRansition #H0000
```

. . :NTRansition?

Query of the negative transition filter of the OPERation status register

Parameters:

none

Result:

Depending on the setting by the FORMat:SREGister command, the contents of the register is transferred as a decimal, binary or hexadecimal value in ASCII code.

Example:

```
STATus:OPERation:NTRansition? -> 0
```

. . :PTRansition <numeric_value>

Setting the positive transition filter of the OPERation status register

Parameters:

<numeric_value> value of the PTRansition section (0..65535 or
#H0000..#HFFFF or #B0..#B1111111111111111)

**RST state:*

will not be changed by *RST

Example:

STATus:OPERation:PTRansition #B11111111

. . :PTRansition?

Query of the positive transition filter of the OPERation status register

Parameters:

none

Result:

Depending on the setting by the FORMat:SREGister command, the contents of the register is transferred as a decimal, binary or hexadecimal value in ASCII code.

Example:

STATus:OPERation:PTRansition? -> 255

Other STATus commands described below do not directly influence the STATus registers.

. :PRESet

Setting the STATus registers with default values:

Register	ENABLE/PTR/NTR	PRESet value
STATus:OPERational	ENABLE	0
	PTR	65535
	NTR	0
STATus:QUEStionable	ENABLE	0
	PTR	65535
	NTR	0
STATus:TRACe	ENABLE	65535
	PTR	65535
	NTR	0
STATus:EXTension	ENABLE	65535
	PTR	65535
	NTR	0
STATus:OPERation:SWEEp	ENABLE	65535
	PTR	65535
	NTR	0

Parameters:

none

**RST state:*

none, as command is an event

Example:

STATus:PRESet

. :QUEue?
 . . [:NEXT]?

Reads the next entry from the Error Queue.

Parameters:

none

Result:

Next entry of Error Queue

Example:

STATus:QUEue? -> 0, "No Error"

4.5.16 SYSTEM subsystem

SYSTEM:AUDIo:BALance <numeric_value> MINimum|MAXimum

Sets the balance of AF for the headphones.

Parameters:

<numeric_value>	balance of AF from -0.5 to +0.5
	-0.5 = only left channel
	0 = mid position
	0.5 = only right channel
MINimum MAXimum	only left AF channel only right AF channel

Remark:

The parameter is rounded to the next internally settable discrete value.

**RST state:*

0

Example:

SYSTEM:AUDIo:BALance 0.5

. :AUDIo:BALance? MINimum|MAXimum

Query of AF balance.

Parameters:

none	
MINimum MAXimum	min. max. value

Example:

SYSTEM:AUDIo:BALance? -> 0.5

. :AUDio:REMOte:MODE <numeric_value>

Sets the mode of the digital AF that is transferred via the remote control interface per UDP. See also Appendix F.

Parameter:

<numeric_value> Mode 0 to 13 of digital AF

Mode	Sampling rate [kHz]	Bits pro sample	Channels	Data rate [kbyte/s]	Length per frame [bytes]
0	-	-	-	0	
1	32	16	2	128	1
2	32	16	1	64	2
3	32	8	2	64	2
4	32	8	1	32	1
5	16	16	2	64	4
6	16	16	1	32	2
7	16	8	2	32	2
8	16	8	1	16	1
9	8	16	2	32	4
10	8	16	1	16	2
11	8	8	2	16	2
12	8	8	1	8	1
13	GSM 6.10	-	1	1.625	65

GSM 6.10 is a standard for the compression of AF data

*RST status:

0

Example:

SYSTem:AUDio:REMOte:MODE 5

. :AUDio:REMOte:MODE?

Query of the set digital AF mode.

Parameter:

None

Example:

SYSTem:AUDio:REMOte:MODE? -> 5

. :AUDio:VOLume <numeric_value>|MINimum|MAXimum

Sets the volume of AF for loudspeakers and headphones.

Parameters:

<numeric_value>	volume of AF from 0 to 1
	0 = no AF
	1 = full volume of AF
MINimum MAXimum	no AF full volume of AF

Remark:

The parameter is rounded to the next internally settable discrete value.

**RST state:*

0.2

Example:

SYSTEM:AUDio:VOLume 0.5

. :AUDio:VOLume? [MINimum|MAXimum]

Query of AF volume.

Parameters:

none	
MINimum MAXimum	min. max. volume

Example:

SYSTEM:AUDio:VOLume? -> 0.5

. :BEEPer:VOLume <numeric_value>|MINimum|MAXimum

Sets the volume of the beeper.

Parameters:

<numeric_value>	volume of beeper from 0 to 1
	0 = beeper off
	0.01 to 0.5 = beeper soft
	0.51 to 1 = beeper loud
MINimum MAXimum	beeper off beeper loud

Remark:

The volume of the beeper can be set in 3 discrete steps only. The parameter is therefore rounded to the next discrete value.

**RST state:*

1

Example:

SYSTEM:BEEPer:VOLume 0.3

. :BEEPer:VOLume? [MINimum|MAXimum]

Query of volume of beeper.

Parameters:

none	
MINimum MAXimum	min. max. volume

Example:

SYSTEM:BEEPer:VOLume? -> 0.5

. :COMMunicate:SERial:BYTeesc <Boolean>

Switch-on and off of the byte-escaping mechanism for serial transmission. See also Appendix A.

Parameter

ON	Activation of byte escaping
OFF	Deactivation of byte escaping

Example:

```
SYSTEM:COMMunicate:SERial:BYTeesc ON
```

. :COMMunicate:SERial:BYTeesc?

Query whether the byte-escaping mechanism for serial transmission is switched on or off.

Parameter:

None

Example:

```
SYSTEM:COMMunicate:SERial:BYTeesc? -> 1
```

. :ERRor?

Reads the next input from Error Queue

Parameters:

none

Result:

Next entry of Error Queue. If the Error Queue is empty, 0, "No Error" is output

Example:

```
SYSTEM:ERRor? -> 0, "No Error"
```

. :KLOCK<Boolean>

Unlocking and locking the keyboard and the rollkey. In the locked state, !KEYBOARD LOCKED BY REMOTE! is indicated on the front-panel display. The string can be configured by means of the SYSTem:KLOCK:LABel command.

This command is advantageous if EB200 in systems is controlled via remote and the setting of parameters via the front-panel control should be prevented.

Parameters:

ON keyboard and rollkey are locked
OFF keyboard and rollkey are unlocked

**RST state:*

OFF

Example:

SYSTem:KLOCK ON

. :KLOCK?

Query of state of keyboard and rollkey.

Parameter:

None

Result:

1 keyboard and rollkey are locked
0 keyboard and rollkey are unlocked

Example:

SYSTem:KLOCK? -> 0

. :KLOCK:LABEL <string>

Entry of user-defined information string indicated on the front-panel display in the state SYSTem:KLOCK ON state. The user can be informed why manual control is currently not allowed by the system under remote control.

Parameters:

<string> ASCII string with 30 characters at max.

**RST state:*

"KEYBOARD LOCKED BY REMOTE! "

Example:

SYSTem:KLOCK:LABEL "THIS IS A TEST"

. :KLOCK:LABEL?

Query of currently set information string.

Parameters:

none

Result:

<String> ASCII string with 30 characters at max.

Example:

SYSTem:KLOCK:LABEL? -> "THIS IS A TEST"

. :SECurity**. . :OPTion <name>**

A special optional firmware (eg DSCAN) can be activated by entering a certain option code. The unit must be switched on anew to activate this optional software.

Parameters:

<name> 8-digit number input

**RST state:*

none

Example:

SYSTem:SECurity:OPTion "12345678"

. **:SPEaker**
. . **:STATE <Boolean>**

Switching the built-in loudspeaker on or off

Parameters:

ON loudspeaker on
OFF loudspeaker off

**RST state:*

ON

Example:

SYSTEM:SPEaker:STATE ON

. . **:STATE?**

Query of loudspeaker

Parameters:

none

Result:

1 loudspeaker on
0 loudspeaker off

Example:

SYSTEM:SPEaker:STATE? -> 1

. **:VERSion?**

Query of SCPI standard used by the device

Parameters:

none

Result:

Version in format YYYY.V, where YYYY stands for the corresponding version year and V for the corresponding revision number of this year.

Example:

SYSTEM:VERSion? -> 1996.0

4.5.17 TEST subsystem

The self-test can be run with two different test routines. The basic test runs continuously in the background and tests the test points inside the module. Based on this test, a "short test" or a "long test" can be triggered. In the short test, a line spectrum is fed in at the antenna input and the receiver is set to the line frequency nearest to the receive frequency. The complete receive path from the antenna input of the tuner to the level evaluation is then measured and evaluated. In the long test, each line frequency of the test spectrum is set and measured.

TEST? SHORT|LONG, REPort|QUIet

Triggering the "short test" or "long test"

Parameters:

SHORT LONG	carry out short test long test
REPort QUIet	error messages in plain text are generated not generated

Note:

When the test was triggered with REPort plain text error messages will be stored in the error queue. They can be queried with SYStem:ERRor?.

Result:

0	no error detected
≠ 0	error detected :

Example:

```
TEST? LONG, QUIET -> 1
```

4.5.18 TRACe subsystem

Traces are used for summarizing data. The following traces are available:

Result trace:

For the results, two predefined traces (MTRACE = Measurement Trace and ITRACE = Information Trace) are available. They cannot be deleted.

Via the control instruction, a condition can be defined which can preselect the data to be written into the MTRACE or ITRACE. If the control conditions of the two traces are identical, each TRACE value has a corresponding information value in the ITRACE. When the maximum data set length is attained, MTRACE and ITRACE are closed down. Any subsequent data are thus lost.

MTRACE receives its data from the SENSE:FUNCTION block. All sensor functions switched on deliver their measured values to the MTRACE where they are stored.

ITRACE receives its data from the SENSE:FREQUENCY block. In addition to the current receiver frequency the corresponding channel number is also stored.

The start command to initiate measurement (INITiate[:IMMEDIATE]) clears the MTRACE (or ITRACE) data set.

IF Panorama Trace IFPAN

If the hardware option EB200SU (IF panorama) is installed, spectrum data can be queried via Trace IFPAN.

The command

```
TRACe:FEED:CONTRol IFPAN, ALWays
```

starts loading of the IFPAN Trace. The command

```
DISPlay:MENU IFPAN
```

starts the IF panorama.

The data will be output in a raw form, ie like they are calculated by the DSP. The spectrum length depends on the bandwidth chosen and will be between 770 and 1230 pixels. The current number of pixels can be queried by the command

```
TRACe:POINTs? IFPAN
```

Suppress trace:

Remote sees the suppress lists as predefined traces. Each data set contains two traces with the names `SSTART` (= Suppress START) and `SSTOP` (=Suppress STOP).

The suppress list has 100 elements with each element consisting of two frequencies. The frequency pair specifies a frequency range which is suppressed during the scan. It is irrelevant that the 1st frequency is lower than the 2nd frequency. The sequence in the list is irrelevant, too. Gaps are specified by the frequency pair 0.0. If one frequency of the frequency pair is 0, the other frequency of the pair is seen as a single frequency.

Examples:

1st Frequency	2nd Frequency	Description
118000000	136000000	Suppression of range 118 to 136 MHz
98550000	98450000	Suppression of range 98,450 to 98,550 MHz
0	0	Empty frequency pair (irrelevant)
118375000	0	Suppress single frequency 118,375 MHz
0	123400000	Suppress single frequency 123,400 MHz
127675000	127675000	Suppress single frequency 127,675 MHz

In the status reporting system the states of the traces are coded in status bits (see "Status reporting system" on page 127).

TRACe? SSTART|SSTOP

This query causes that the data will be taken from the already corrected table.

1st frequency	2nd frequency
118000000	136000000
98450000	98550000
0	0
118375000	118375000
123400000	123400000
127675000	127675000

Clearing the suppress lists must always include both commands (TRAC SSTART, 0; TRAC SSTOP, 0).

TRACe|DATA

Note:

Instead of command word TRACe also DATA can be used.

. :CATalog?

Query of all defined trace names

Parameters:

none

Result:

"MTRACE", "ITRACE", "IFPAN", "SSTART", "SSTOP"

TRACe

. [:DATA] <trace_name>, <numeric_value> {, <numeric_value>} | <block>

Writing data to a trace.

Note:

Only the suppress traces can be written to.

Error messages:

If the trace name is unknown or not identical with a suppress trace, error -141 "Invalid character data" is generated.

If too many data are loaded in a suppress trace, error -223 "Too much data" is generated.

Parameter:

<trace-name> name of the trace to be written to as <Character Data>
SSTART

<numeric_value> list of frequencies. If the list is not complete, the rest of the trace is filled with 0.

Note:

In contrast to the SCPI standard a single value is not used for the complete trace!

<block> As an alternative to the frequency list a <Definite Length Block> can be transmitted with the following structure:
Frequency list with frequencies in Hz, 4 bytes per frequency.

**RST state:*

No change of trace contents at *RST.

Example:

TRACe SSTART, 123.475 MHz, 118000000, 98550 kHz

. **[:DATA] <trace_name>**

Query of trace data

Error message:

If the trace name is unknown, an error -141, "Invalid character data" will be generated.

Parameters:

<trace_name> name of desired trace as <Character Data> (MTRACE, ITRACE, IFPAN or SSTART, SSTOP)

Result:

The following is valid for MTRACE:

Output of measured values of all sensor functions switched on. If no function is switched on, NaN (Not a Number) is output.

If `FREQ:OFFS` is switched on, only the offset value is output. If `VOLT:AC` is switched on, only the level value is output. If `FREQ:OFFS` and `VOLT:AC` are switched on, first the level value and then the offset value are output.

The INF value 9.9E37 is entered into the result buffers MTRACE and ITRACE for MSCAN, FSCAN or DSCAN to identify the range limit.

The following is valid for ITRACE:

Output of channel number and receive frequency.

Depending on the setting, the output format is defined by the `FORMat:DATA` command:

`ASCIi` -> normal ASCII output:

- level in dBuV
- offset in Hz signed
- field strength in dB μ V/m with sign
- channel number without unit
- frequency in Hz

`PACKed` -> <Definite Length Block>: (see "**Block data**" on page 11)

- level in 1/10 dBuV (2 bytes)
- offset in Hz (4 bytes)
- field strength in 1/10 dBuV (2 bytes)
- channel number (2 bytes)
- frequency in Hz (4 bytes)

Note:

The sensor function `FSTRength` will only provide results if the SW option EB200FS is fitted. Also see Annex H.

Notes:

- INF (range limit flag) will be coded in the `PACKed` format as follows:
 INF level = 2000
 INF offset = 10000000
 INF FSTR = 0x7FFF
 INF freq = 0
 INF channel = 0

- NINF (no measurement possible) will be coded in the PACKed format as follows:
 NINF offset = 10000000-1
 NINF FSTR = 0x7FFE no k- factor defined on this frequency
 NINF AM = 0x7FFE
 NINF FM = 0x7FFF FFFE
 NINF PM = 0x7FFE
 NINF BW = 0x7FFF FFFE
 The level can be measured any time.
- NaN is output as #110 in the PACKed format
- To ensure that for the two traces the same number of points is output, the two queries have to be one directly behind the other in the same command line (eg TRACE? MTRACE;TRACE? ITRACE).

Example:

```
TRACE? MTRACE -> 23.4, -2500, 18.5, 1500
```

The following is valid for the IFPAN trace:

Output of the spectrum data. If there are no data available then a NaN (Not a Number) will be output.

The output format of the IFPAN trace depends on the settings made by command FORMat:DATA.

AScii -> normal ASCII output:

- level in dB μ V

PACKed -> <Definite Length Block>:

- level in 1/10 dB μ V (2 bytes)

The following is valid for the suppress trace:

List of frequencies contained in the trace. The suppress-trace output format is defined, according to the relevant setting, through command FORMat:DATA:

AScii -> Normal ASCII output:

- list of frequencies in Hz

PACKed -> <Definite Length Block>

- list of frequencies in Hz, 4 bytes per frequency

Example:

```
TRACE? SSTART -> 123475000, 118000000, 98550000
```

. :FEED? <trace_name>

Query of data block connected with the trace

Error message:

If the trace name is unknown, an error -141, "Invalid character data" will be generated.

Parameters:

<trace_name> see TRACe[:DATA]?

Result:

Name of the block coupled to the trace.

The following is valid for MTRACE: "SENS"

The following is valid for ITRACE: "FREQ"

The following is valid for IFPAN: "SENS"

Example:

TRACe:FEED? MTRACE -> "SENS"

. . :CONTRol <trace_name>, ALWays|SQUelch|NEVer

Control of trace loading

Error message:

If trace name is unknown, an error -141, "Invalid character data" will be generated.

Note:

For IFPAN Trace, only ALWays or NEVer can be selected.

Parameters:

<trace-name> see TRACe[:DATA]?

ALWays all data are stored

SQUelch data are first stored, if the signal has exceeded the squelch threshold defined in the OUTPUT:SQUelch subsystem

NEVer do not store any data in the trace.

**RST state:*

NEVer

Example:

TRACe:FEED:CONTRol MTRACE, ALWays

. . :CONTRol? <trace_name>

Query of trace loading

Error message:

If the trace name is unknown, an error -141, "Invalid character data" will be generated.

Parameters:

<trace_name> see TRACe[:DATA]?

Result:

ALW, SQU, NEV

Example:

TRACe:FEED:CONTRol? MTRACE -> ALW

- . **:LIMit**
- . . **[:UPPer] <trace_name>, <numeric_value>|MINimum|MAXimum**

Setting the limit of a trace. If the limit is exceeded, the `Limit exceeded Flag` will be set in the `STATus:TRACe` register.

Error message:

If the trace name is unknown, an error -141, "Invalid character data" will be generated.

Parameters:

<trace_name>	see TRACe[:DATA]?
<numeric_value>	limit in percent of the maximum trace length
MINimum MAXimum	setting the least greatest limit

**RST state:*

50 PCT

Example:

TRACe:LIMit MTRACE, 50 PCT

- . . **[:UPPer]? <trace_name>[,MINimum|MAXimum]**

Query of trace limit

Error message:

If the trace name is unknown, an error -141, "Invalid character data" will be generated.

Parameters:

<trace_name>	see TRACe[:DATA]?
no further parameter	query of current limit
MINimum MAXimum	query of least greatest limit

Result:

Limit in percent of maximum trace length

Example:

TRACe:LIMit? MTRACE -> 50

. :POINTs? <trace_name>[,MINimum|MAXimum]

Query of number of values stored in a trace

The number of values stored in the suppress traces is always 100. Thus, the MAXimum and MINimum value is also 100.

The number of values stored under IFPAN depends on the IF bandwidth and is between 770 and 1230.

Error message:

If the trace name is unknown, an error -141, "Invalid character data" will be generated.

Parameters:

<trace_name>	see TRACe[:DATA]?
no further parameter	query of current number
MINimum MAXimum	query of lowest highest number

Result:

Number of values

Example:

```
TRACe:POINTs? MTRACE, MAX -> 2048
```

. . :AUTO? <trace_name>

Query of trace length (auto-adjust)

A 0 (no auto-adjust for trace length) is always output for a suppress trace.

Error message:

If the trace name is unknown, an error -141, "Invalid character data" will be generated.

Parameters:

<trace_name>	see TRACe[:DATA]?
--------------	-------------------

Result:

0	no auto-adjust for trace length
1	auto-adjust for trace length

Example:

```
TRACe:POINTs:AUTO? MTRACE;AUTO? ITRACE -> 1;1
```

. . :VALue? <trace_name>, <index>, <numeric_value>

Setting an element of a trace.

Note:

Only suppress traces can be set.

Error message:

If the trace name is unknown or not equal to a suppress trace name, an error -141, "Invalid character data" is generated.

Parameters:

<trace_name>	name of the trace to be set as <Character Data> SSTART1, SSTOP
<index>	Index of the element within the trace that is to be set. The first element of a trace has the index 0.
<numeric_value>	frequency value of the element

**RST state:*

see TRACE:DATA

Example:

TRACe:VALue SSTART, 13, 98.550 MHz

. . :VALue? <trace_name>, <index>

Query of an element of a trace.

Note:

Only elements of the suppress traces can be queried.

Error message:

If the trace name is unknown or not equal to a suppress trace name, an error -141 "Invalid character data " is generated.

Parameters:

<trace_name>	name of the trace to be read as <Character Data> SSTART, SSTOP
<index>	Index of the element within the trace that is to be set. The first element of a trace has the index 1.

Result:

Frequency value of the element of a trace in Hz

Example:

TRACe:Value? SSTART, 13 -> 98550000

4.5.19 TRIGger subsystem

The trigger subsystem is used to synchronize actions within the unit with events.

With SW option EB200CM (Coverage Measurement) triggered level measurements can be carried out. The trigger source is selected by using command `TRIGger:SOURce EXTernal|INTernal|TIMER`. See also Annex G (Coverage Measurement).

TRIGger[:SEQUence]

. :SLOPe POSitive|NEGative

Setting of the slope initiating a trigger via rear-panel connector X8, pin 12 in FASTlevcw and LIST modes

Parameters:

POSitive	trigger at positive slope
NEGative	trigger at negative slope

**RST state:*

POSitive

Example:

TRIGger:SLOPe NEGative

. :SLOPe?

Query of the slope initiating a trigger via rear-panel connector X8, pin 12 in FASTlevcw and LIST modes

Parameters:

none

Result:

NEG, POS

Example:

TRIGger:SLOPe? -> NEG

. :SOURce EXTernal|INTernal|TIMer

Selection of the trigger source in modes FASTlevcw and LIST

Parameters:

EXTernal

Trigger is performed via an impulse to rear-panel connector X8, pin 12. The trigger slope can be selected with command TRIGger:SLOPe.

INTernal

Trigger is performed internally as quickly as possible. As soon as a measurement is completed the next one begins.

TIMer

Trigger is initiated by a periodic timer. The timer period can be set with command TIMer.

**RST state:*

INTernal

Example:

TRIGger:SOURce EXTernal

. :SOURce?

Query of currently set trigger source

Parameters:

none

Result:

EXT, INT, TIM

Example:

TRIGger:SOURce? -> EXT

. :TImEr<numeric_value>|MINimum|MAXimum

Setting the period of the timer which in timer-triggered measuring mode is the trigger source

Note:

The timer period is rounded to internally adjustable values. The rounded value is output when a query with command `TRIGger:TImEr?` is started.

Parameters:

<numeric_value>	measuring time in seconds
MINimum MAXimum	minimum/maximum measuring time

**RST state:*

MAXimum

Example:

`TRIGger:TImEr 10 ms`

. :TImEr? [MINimum|MAXimum]

Query of set trigger period

Parameters:

none	query of current trigger period
MINimum MAXimum	query of shortest/longest trigger period

Result:

Trigger periods in seconds

Example:

`TRIGger:TImEr? -> 0.099986`

4.6 Device model and command processing

The following figure shows the basic structure of the unit under firmware aspects. The actual receiver is isolated from the front control panel and the remote control units by a central data memory. This memory is at the core of the EB200 firmware and deals with the following tasks:

- Administration of connected modules (receiver, front control panel, remote clients)
- Making data available to the receiver (eg receive frequency, scan parameters, etc.)
- Sequentialization of settings for simultaneous manual and remote control
- Sending messages on parameter changes to all modules.
- Storing data in the CMOS RAM for protection against power failure

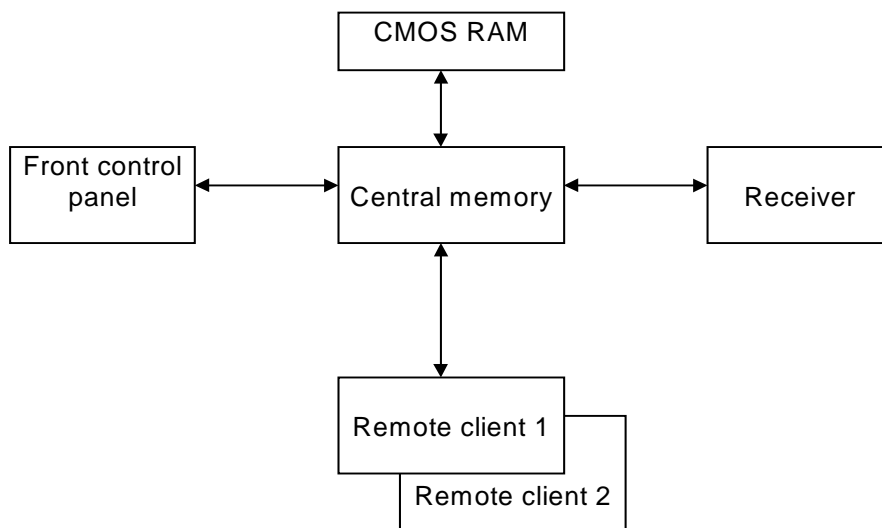

Fig. 4-2: Device model with remote control

As mentioned under 4.3, the unit can be controlled from the front panel and one or several remote control units – the remote clients – simultaneously (competitive control). Upon system start, the front control panel and the receiver are logged in to the data memory automatically. These modules are therefore always connected. The remote clients are logged in if a host computer sets up a link to the EB200.

The receiver obtains the required data (receive frequency, bandwidth, etc.) from the memory. It has no data storage facility of its own and therefore has direct access to the central memory.

Due to the principle of competitive control, different clients can modify the same parameters. The central memory sequentializes the access procedures (last client wins) and sends messages to the other users that a parameter has been changed.

Example 1:

Remote client 1 modifies the frequency value. The central memory signals to the receiver that a new frequency is to be set. The front control panel is supplied with the new frequency. Remote client 2 (if connected) receives a modification report (see "STATus:EXTension register" on page 138).

Example 2:

If the receive frequency is changed by the receiver due to a scanning procedure or an AFC correction, this is reported to remote clients 1 and 2. The front control panel receives the new receive frequency and displays it.

A large number of parameters have to be stored power-failure-proof. This is ensured by the central memory: it stores all modifications of the relevant parameters in the CMOS RAM and assigns them to checksums. Upon switching on the unit, the checksums are checked, and the data are retrieved from the CMOS RAM or default values are used.

4.6.1 Remote client

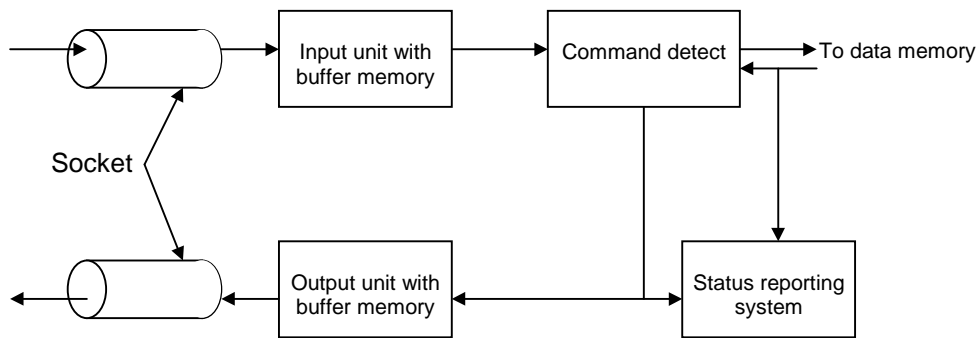
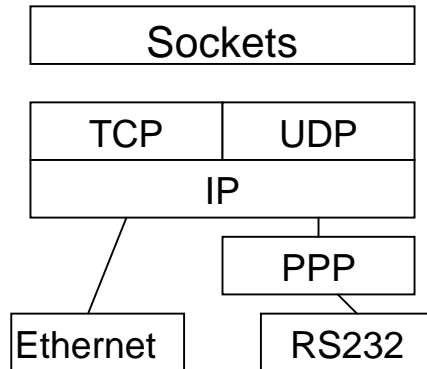

Fig. 4-3: Structure of a remote client within the firmware

Sockets:

The remote clients are connected to the host computer by so-called sockets. These are logic point-to-point links that are independent of the transmission medium used. Sockets are based on the Transmission Control Protocol (TCP) or the User Datagram Protocol (UDP). These two protocols are in turn based on the Internet Protocol (IP). The following figure shows the layer model of the sockets.



The transmission media are located beneath the IP layer. EB200 is fitted with an RS232-compatible interface as standard. This interface is coupled to the IP layer by means of the Point-to-Point Protocol (PPP). This is necessary because IP is a packet-oriented protocol. It is not necessary if the optional LAN interface is used, because the Ethernet protocol of this interface is already packet-oriented.

The use of sockets has several advantages:

- the protocols used (PPP, IP, TCP, UDP) are standardized and implemented on all customary operating systems (WindowsNT, Windows95, Windows 3.1, UNIX, SunOS, and many more).
- TCP links are protected against transmission errors.
- Host software can be generated independent of the transmission medium used (LAN or RS232).
- Several logic links may use the same transmission medium.
- IP routing enables access also to remote units also over great distances (eg via the Internet).

When the unit is started, a so-called list socket is generated. It functions as the unit's "receptionist". Each host wishing to remote-control the EB200 has to log in with the list socket first. The list socket then generates a new remote client and allocates the link to a new socket so the list socket remains free to receive further hosts.

For login at the list socket, the host needs to have the address and port number of the unit. This can be set in the Setup Remote menu.

Input unit:

Data transmission via sockets is packet-oriented. Each packet received is handed over to command recognition.

Command detect:

Command detect analyzes the data received from the input unit. Data are processed in the sequence they have been received. The data received consist of strings that have to be in accordance with the SCPI standard. The SCPI standard is based on the IEEE 488 standard. Normally, this standard only applies to IEC/IEEE bus (also referred to as IEC625, HPIB or GPIB). Another IEEE standard, IEEE 1174, is a supplement to IEEE 488, making it applicable also to serial links (RS232). EB200 uses this standard as a basis for SCPI commands via sockets.

Each identified setting command contained in an SCPI string is first stored in a buffer memory. Only a <Program Message Terminator> (line feed) or a query command will cause the setting commands to be sent to the data memory, where they are checked for consistency. If the commands are consistent, they will be executed at once, and the other modules will be informed. Query commands generate a request to the memory. The memory sends back the data, which will then be processed according to the SCPI standard by the command detect. Finally, the SCPI response strings are sent to the output unit.

Output unit:

The output unit collects all data in the output buffer that were generated in response to query commands. If the command detect identifies the end of an SCPI command (by the <Program Message Terminators>), it causes the output unit to send the data in the output buffer to the host computer via the socket.

Status reporting system:

The Status Reporting System gathers information on the device status and makes it available to the output unit on request. The Status Reporting System may be used for messaging asynchronous events (eg error statuses, availability of results, data modifications by other users, etc.) to the host computer.

4.6.2 Data memory

This figure shows the classification of data into data groups. These groups are also reflected by the Status Reporting System of the remote clients in the extension register status.

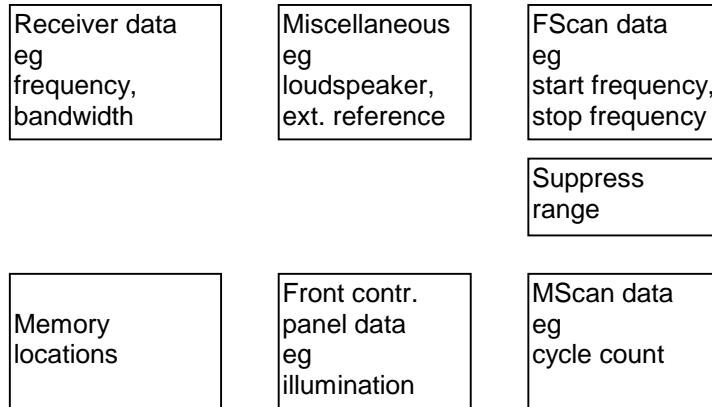

4.7 Status reporting system

The status reporting system (see Fig. 4-5) stores all the information on the present operating state of the device, eg that the device presently carries out a SWEEPing, and on errors which have occurred. This information is stored in the status registers and in the error queue. For each remote client there is a separate status reporting system and access to all registers of the error queue.

The information is of hierarchical structure. The register status byte (*STB*) defined in IEEE 488.2 and its associated mask register service request enable (*SRE*) form the uppermost level. The *STB* receives its information from the standard event status register (*ESR*) which is also defined in IEEE 488.2 with the associated mask register standard event status enable (*ESE*) and registers *STATUS:OPERation* and *STATUS:QUESTionable* which are defined by SCPI, the registers *STATUS:TRACe* and *STATUS:EXTension* not specified by SCPI as well as the two queues error queue and message queue.

The IST flag ("Individual *STatus*") and the parallel poll enable register (*PPE*) allocated to it are also part of the status reporting system. The IST flag, like the SRQ, combines the entire device status in a single bit. The *PPE* fulfils a function for the IST flag as the *SRE* does for the service request.

The message queue contains the messages the device sends back to the controller. It is not part of the status reporting system but determines the value of the MAV bit in *STB* and is thus shown in Fig. 4-5.

4.7.1 Structure of an SCPI status register

Each SCPI register consists of 5 sections each having a width of 16 bits and different functions (see Fig. 4-4). The individual bits are independent of each other, ie a bit number being valid for all five sections is assigned to each hardware status. Bit 3 of the STATUS:OPERATION register for example is assigned to the hardware status "SWEeping" in all five sections. Bit 15 (the most significant bit) is set to zero for all sections. Thus the contents of the register sections can be processed by the controller as positive integers.

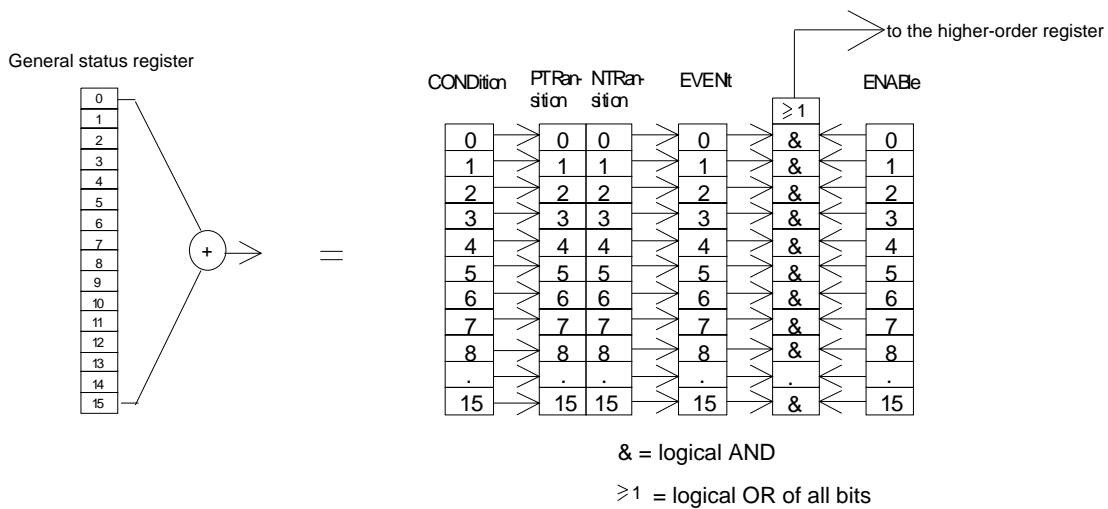

Fig. 4-4 : Status register model

CONDition section the CONDition section of a register reflects directly the state of the hardware. This register section can only be read. Its contents is not changed during reading.

As an alternative, a bit in a CONDition register can also contain the summary information of a further status register connected in front. In this case, the bit is cleared on reading out the status register.

PTRansition section the Positive-TRansition section acts as an edge detector. When a bit of the CONDition section is changed from 0 to 1, the associated PTR bit decides whether the EVENT bit is set to 1.

- PTR bit =1: the EVENT bit is set.
- PTR bit =0: the EVENT bit is not set.

This section can be written into and read in any way. Its contents is not changed during reading.

NTRansition section the Negative-TRansition section also acts as an edge detector. When a bit of the CONDition section is changed from 1 to 0, the associated NTR bit decides whether the EVENT bit is set to 1.

NTR-bit = 1: the EVENT bit is set.

NTR-bit = 0: the EVENT bit is not set.

This section can be written into and read in any way. Its contents is not changed during reading.

with these two edge register sections the user can define which state transition of the condition section (none, 0 to 1, 1 to 0 or both) is stored in the EVENT section.

EVENT section the EVENT section indicates whether an event has occurred since the last reading, it is the "memory" of the CONDition section. It only indicates events passed on by the edge filters. The EVENT section is permanently updated by the device. This part can only be read. During reading, its contents is set to zero. This section is often regarded as the entire register.

ENABLE section the ENABLE section determines whether the associated EVENT bit contributes to the summary bit (see below). Each bit of the EVENT section is ANDed with the associated ENABLE bit (symbol '&'). The results of all logical operations of this section are passed on to the summary bit via an OR function (symbol '≥ 1').

ENABLE bit = 0: the associated EVENT bit does not contribute to the summary bit

ENABLE bit = 1: if the associated EVENT bit is "1", the summary bit is set to "1" as well.

This section can be written into and read by the user in any way. Its contents is not changed during reading.

Summary bit as indicated above, the summary bit is obtained from the EVENT and ENABLE section for each register. The result is then entered into a bit of the CONDition section of the higher-order register.

The device automatically generates the summary bit for each register. Thus an event, eg a PLL that has not locked, can lead to a service request through all the hierarchy levels.

Note: *The service request enable register SRE defined in IEEE 488.2 can be taken as ENABLE section of the STB if the STB is structured according to SCPI. By analogy, the ESE can be taken as the ENABLE section of the ESR.*

4.7.2 Overview of the status registers

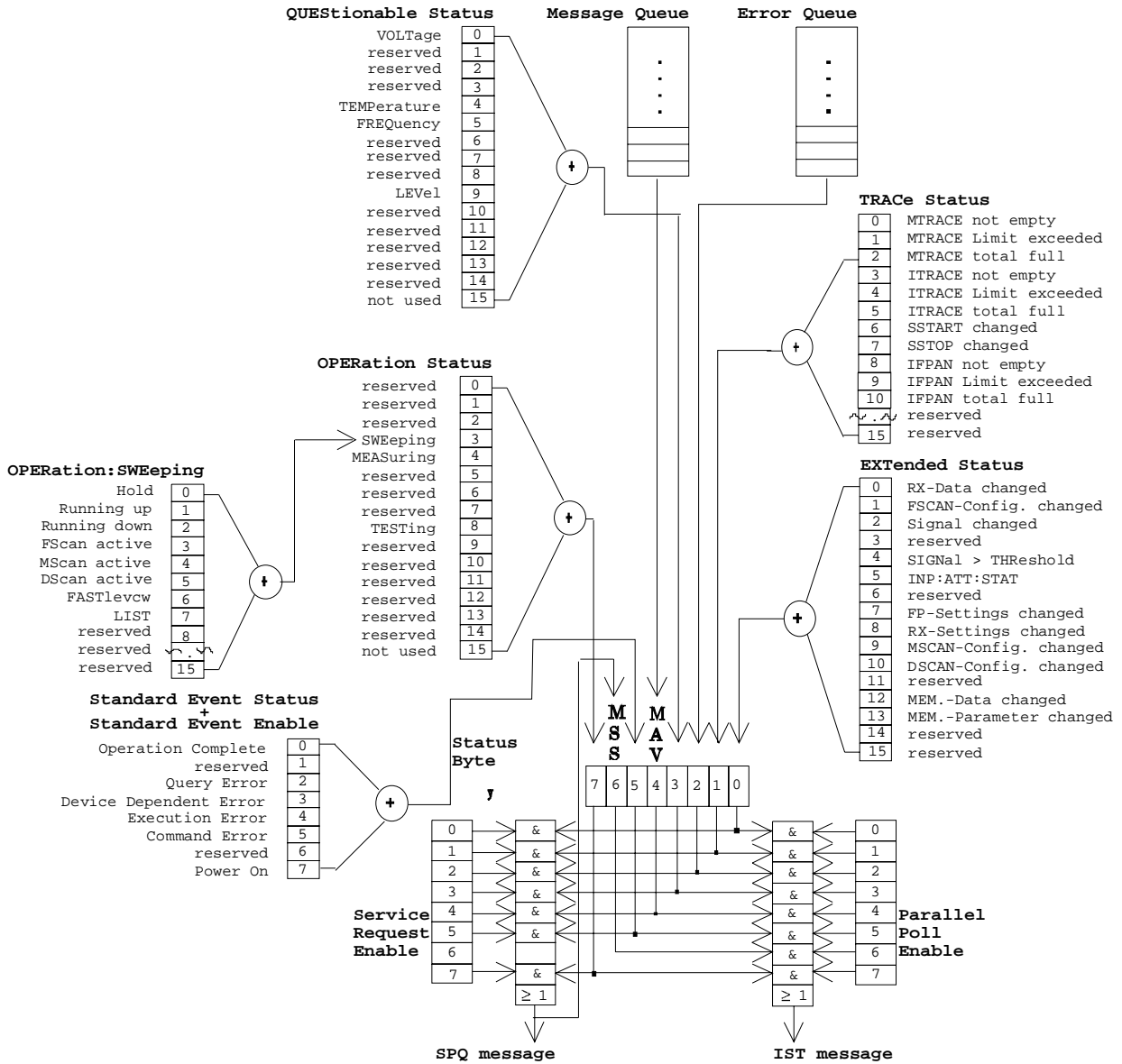

Fig. 4-5: Overview of status registers

4.7.3 Description of the status registers

4.7.3.1 Status Byte (STB) and Service Request Enable Register (SRE)

The STB is already defined in IEEE 488.2. It provides an overview of the device status by collecting the pieces of information of the lower registers. It can thus be compared with the CONDition section of an SCPI register and assumes the highest level within the SCPI hierarchy. A special feature is that bit 6 acts as the summary bit of the remaining bits of the status byte.

The STATUS BYTE is read out using the command "`*STB?`" or a "serial poll".

The STB implies the SRE. As to its function, it corresponds to the ENABLE section of the SCPI register. A bit in the SRE is assigned to each bit of the STB. Bit 6 of the SRE is ignored. If a bit is set in the SRE and the associated bit in the STB changes from 0 to 1, a Service Request (SRQ) is generated, which triggers an interrupt in the controller if this is appropriately configured.

The SRE can be set using command "`*SRE`" and read using "`*SRE?`".

Table 4-2 Bit allocation of status byte

Bit no.	Meaning
0	<p>EXTended status register summary bit</p> <p>The bit is set if an EVENT bit is set in the EXTended status register and if the corresponding ENABLE bit is set to 1. The states of the hardware functions and change bits are combined in the EXTended status register.</p>
1	<p>TRACe status register summary bit</p> <p>The bit is set if an EVENT bit is set in the TRACe status register and if the corresponding ENABLE bit is set to 1. The states of the TRACes MTRACE, ITRACE, SSTART and SSTOP are represented in the TRACe status register.</p>
2	<p>Error Queue not empty</p> <p>The bit is set when the error queue contains an entry.</p> <p>If this bit is enabled by the SRE, an entry into the empty error queue generates a service request.</p> <p>Thus, an error can be recognized and specified in greater detail by polling the error queue. The poll provides an informative error message. This procedure is recommended since it considerably reduces the problems involved with the control.</p>
3	<p>QUESTionable status register summary bit</p> <p>The bit is set if an EVENT bit is set in the QUESTionable status register and the corresponding ENABLE bit is set to 1. A set bit indicates a questionable device status which can be specified in greater detail by polling the QUESTionable status register.</p>
4	<p>MAV bit (message available)</p> <p>No meaning</p>
5	<p>ESB bit</p> <p>Summary bit of the EVENT status register. It is set if one of the bits in the EVENT status register is set and enabled in the EVENT status enable register.</p> <p>Setting of this bit implies a serious error which can be specified in greater detail by polling the EVENT status register.</p>

Bit no.	Meaning
6	<p>MSS bit (master status summary bit)</p> <p>The bit is set if the device triggers a service request. This is the case if one of the other bits of this registers is set together with its mask bit in the service request enable register SRE.</p>
7	<p>OPERation status register summary bit</p> <p>The bit is set if an EVENT bit is set in the OPERation status register and the corresponding ENABLE bit is set to 1. A set bit indicates that the device is just performing an action. The type of action can be determined by polling the QUEStionable status register.</p>

4.7.3.2 IST flag and Parallel Poll Enable (PPE) register

Analogous to the SRQ, the IST flag combines the entire status information in a single bit. It can be queried by using command "`*IST?`".

The parallel poll enable register (PPE) determines which bits of the STB contribute to the IST flag. The bits of the STB are ANDed with the corresponding bits of the PPE. In contrast to SRE bit 6 is also used here. The IST flag results from the ORing of all results. The PPE can be set using the "`*PRE`" commands and read using the "`*PRE?`" command.

4.7.3.3 Event Status Register (ESR) and Event Status Enable (ESE) register

The ESR is already defined in IEEE 488.2. It can be compared with the EVENT section of an SCPI register. The EVENT status register can be read out using the "*ESR?" command .

The ESE is the associated ENABLE section. It can be set using the "*ESE" command and read using the "*ESE?" command .

Table 4-3 Bit allocation of event status register

Bit No.	Meaning
0	<p>Operation Complete</p> <p>This bit is set on receipt of the command *OPC exactly when all previous commands have been executed.</p>
2	<p>Query Error</p> <p>This bit is set if either the controller wants to read data from the device without having sent a query, or if it does not fetch requested data and sends new instructions to the device instead. The cause is often a query which is faulty and hence cannot be executed.</p>
3	<p>Device-dependent error</p> <p>This bit is set if a device-dependent error occurs. An error message with a number between -300 and -399 or a positive error number denoting the error in greater detail is entered into the error queue (see Annex B, Error Messages).</p>
4	<p>Execution Error</p> <p>This bit is set if a received command is syntactically correct but cannot be performed for different reasons. An error message with a number between -200 and -299 denoting the error in greater detail is entered into the error queue (see Annex B, Error Messages).</p>
5	<p>Command Error</p> <p>This bit is set if an undefined and syntactically incorrect command is received. An error message with a number between -100 and -199 denoting the error in greater detail is entered into the error queue (see Annex B, Error Messages).</p>
7	<p>Power On (supply voltage on)</p> <p>This bit is set when the device is switched on.</p>

4.7.3.4 STATus:OPERation register

In the CONDition section, this register contains information about the type of actions currently being executed by the device. In the EVENT section, it also contains information about the type of actions having been executed since the last reading. It can be read using the commands

"STATus:OPERation:CONDition?" or

"STATus:OPERation[:EVENT]?" .

Table 4-4 Bit allocation of STATus:OPERation register

Bit No.	Meaning
3	SWEeping This bit is set when the sum bit of STATus:OPERation:SWEeping bits is set
4	MEASuring This bit is set for the duration of a measurement
8	TESTing This bit is set when a self-test is triggered

4.7.3.5 STATus:OPERation:SWEeping register

This register contains more detailed information on the operating state of the device. The device is either set to normal receive mode (fixed frequency) or to one of several scan modes (FSCAN, MSCAN, DSCAN, FASTLEVCW, LIST).

The status is determined by using command `SENSe:FREQuency:MODE`, the `CW|FIXed` status being marked by clearing bits 3 to 7 from the `STATus:OPERation:SWEeping` register.

Table 4-5 Bit allocation of STATus:OPERation:SWEeping register

Bit No.	Meaning
0	Hold This bit is set if an FSCAN or MSCAN was interrupted due to the fulfilment of a hold criterion.
1	Running up This bit is set if sweeping is to be carried out in the direction of increasing frequency values or memory location numbers.
2	Running down This bit is set if sweeping is to be carried out in the direction of decreasing frequency values or memory location numbers.
3	FSCAN active This bit is set if <code>FREQ:MODE</code> is set to <code>SWEep</code> .
4	MSCAN active This bit is set if <code>FREQ:MODE</code> is set to <code>MSCan</code> .
5	DSCAN active This bit is set if <code>FREQ:MODE</code> is set to <code>DSCan</code> (SW option EB200DS).
6	FASTlevcw active This bit is set if <code>FREQ:MODE</code> is set to <code>FASTlevcw</code> (SW option EB200CM).
7	LIST active This bit is set if <code>FREQ:MODE</code> is set to <code>LIST</code> (SW option EB200CM).

4.7.3.6 STATus:QUEStionable register

This register contains information on ambiguous device states. They can occur, for example if the device is operated outside its specification range. It can be queried using the commands `STATus:QUEStionable:CONDition?` or `STATus:QUEStionable[:EVENT]?`.

Table 4-6 Bit allocation of STATus:QUEStionable register

Bit No.	Meaning
0	<p>VOLTage</p> <p>This bit is set if an ambiguous supply voltage occurs. The following voltage test points are to be checked: T-5V, T+3.3V, T+5VD, T+5VSTDFE, T+5VA, T+25V, T5VINT.</p>
4	<p>TEMPerature</p> <p>This bit is set if the internal temperature is too high. The test point TEMP in module S1 will be checked.</p>
5	<p>FREQuency</p> <p>This bit is set if an internal oscillator frequency is ambiguous. The following voltage test points are to be checked: 1ST LO ST, SWP VCO ST, TP 2NDLOPLL, TP_SAM_LEV, TP_VXO_PLL, LDET, TEXREF, TLEVREF</p>
9	<p>LEVel</p> <p>This level is set when the IF section is overdriven by an excessively high input level. The result of a level measurement is then suspect.</p>

4.7.3.7 STATus:TRACe register

This register contains information on ambiguous states of the traces MTRACE, ITRACE, IFPAN, SSTART and SSTOP.

It can be queried with the commands `STATus:TRACe:CONDition?` or `STATus:TRACe[:EVENT]?`.

Table 4-9 Bit allocation of STATus:TRACe register

Bit No.	Meaning
0	MTRACE not empty This bit is set if the MTRACE contains at least one measured value.
1	MTRACE limit exceeded This bit is set if the number of measured values contained in the MTRACE exceeds the threshold given by the command <code>TRACe:LIMit[:UPPer] MTRACE</code> .
2	MTRACE total full This bit is set if the MTRACE is loaded with the maximum number of measured values.
3	ITRACE not empty This bit is set if the ITRACE contains at least one information value.
4	ITRACE limit exceeded This bit is set if the number of measured values contained in the ITRACE exceeds the threshold given by the command <code>TRACe:LIMit[:UPPer] ITRACE</code> .
5	ITRACE total full This bit is set if the ITRACE is loaded with the maximum number of information values.
6	SSTART changed This bit is set if one or several start frequencies of the current suppress table have changed.
7	SSTOP changed This bit is set if one or several stop frequencies of the current suppress table have changed.
8	IFPAN not empty This bit is set if at least one measured value is stored under IFPAN.
9	IFPAN Limit exceeded This bit is set if the number of measured values stored under IFPAN exceeds the threshold set by <code>TRACe:LIMit[:UPPer] IFPAN</code> .
10	IFPAN total full This bit is set if the maximal number of measured values is stored under IFPAN.

4.7.3.8 STATus:EXTension register

This register contains in the CONDition part information on different receiver states which cannot be assigned to the other registers. Information about the actions the unit had carried out since the last read out is stored in the EVENT part. The corresponding registers can be queried with the commands STATus:EXTension:CONDition? or STATus:EXTension[:EVENT]? .

Table 4-10 Bit allocation of STATus:EXTension register

Bit No.	Meaning
0	RX data changed This bit is set if the receiver data set "1" ("job data set") is changed by manual control or by another remote client (see also "Data memory" on page 126).
1	FSCAN configuration changed This bit is set if the FSCAN data set "1" ("job data set") is changed by manual control or by another remote client (see also "Data memory" on page 126).
2	Signal changed This bit is set if the received signal changes in level or offset.
3	COR active This bit is set if the COR relay becomes active.
4	SIGNAL > THReshold This bit is set if the signal level is above the squelch threshold (precondition: squelch is switched on).
5	INPut:ATTenuation:STATe This bit is set if the input attenuator is switched on.
7	FP settings changed This bit is set if the front-panel data set is changed by manual control or by another remote client.
8	RX settings changed This bit is set if a parameter was changed by manual control or by another remote client in the data set "miscellaneous".
9	MSCAN configuration changed This bit is set if the MSCAN data set is changed by manual control or by another remote client .
10	DSCAN configuration changed This bit is set if the DSCAN data set is changed by manual control or by another remote client (DSCAN is an option).
12	MEMory data changed This bit is set if a memory data was changed by manual control or by another remote client.
13	MEMory parameter changed This bit is set if the query bit was changed by manual control or by another remote client.

With bits 0 to 2 and 7 to 10 and 12 to 13, the host can be informed via an SRQ about parameter changes. Cyclical polling of the settings by the host is thus stopped during manual operation or if the signal parameters are to be indicated. In the CONDition section of the register, the change bits are set after manual control or signal change and are reset by special query commands. Changes done by front panel or by another remote client affect the change bits equally.

Table 4-11 Change bit allocation in STATus:EXTension register

Bit No.	Set by change of	Reset by one of the commands
0	Frequency, demodulation, bandwidth, threshold value, MGC value, control mode, antenna number, attenuation, type of detector, squelch enable, squelch control, sensor function, AFC, TONE mode, tone reference threshold, AUX bit(s), AUX output mode, IF-panorama display width, IF-panorama display mode, measuring time	FREQ?, DEM?, BAND?, OUTP:SQU:THR?, GCON?, GCON:MODE?, ROUTe:CLOSe:STATe?, INP:ATT:STAT?, DET?, OUTP:SQU?, OUTP:SQU:CONT?, FUNC?, FREQ:AFC?, MEM:CONT? RX, OUTP:TONE?, OUTP:TONE:THR?, OUTP:BITAx?, OUTP:BYTAX?, OUTP:AUX?, FREQ:SPAN?, CALC:IFPAN:TYPE?, CALC:IFPAN:AVER:TIME?, MEAS:TIME?
1	FSCAN: Start frequency, stop frequency, stepwidth, number of runs, synchronizing time, listening time, scan mode	FREQ:STAR?, FREQ:STOP?, SWE:STEP?, SWE:COUN?, SWE:DWEL?, SWE:HOLD:TIME?, SWE:DIR?, SWE:CONT?
2	Signal level, offset	SENS:DATA?
7	Display variants, display mode, display disable, antenna names, display illumination cut-out time, display brightness	DISP:MENU?, DISP:CMAP?, DISP:ENAB?, ROUT:PATH[:DEF]?, DISP:BRIG?, DISP:BRIG:DWEL?
8	Volume, loudspeaker, balance, external reference, tone monitoring	SYST:AUD:VOL?, SYST:SPE:STAT?, SYST:AUD:BAL?, ROSC:SOUR?, OUTP:TONE:CONT?
9	MSCAN: Number of runs, synchronizing time, listening time, scan mode	MSC:COUN?, MSC:DWEL?, MSC:HOLD:TIME?, MSC:DIR?; MSC:CONT?
10	DSCAN: Center frequency, marker frequency, span frequency, start frequency, stop frequency, BWZOOM, number of runs, display mode, speed, reference level	FREQ:DSC:CEN?, FREQ:DSC:MARK?, FREQ:DSC:SPAN?, FREQ:DSC:STAR?, FREQ:DSC:STOP?, FREQ:DSC:RES?; DSC:COUNT?, CALC:DSC:AVER:TYPE?, FREQ:DSC:SPEED?, VOLT:AC:RANG?
12	Frequency, demodulation, bandwidth, threshold value, antenna number, attenuation, squelch enable, AFC	MEM:CONT? MEM0 ... MEM999 MEM:CONT:MPAR? MEM0 ... MEM999
13	Query bit (set, reset)	MEM:CONT? MEM0 ... MEM999 MEM:CONT:MPAR? MEM0 ... MEM999

4.7.4 Use of the Status Reporting System

In order to be able to effectively use the status reporting system, the information contained there has to be transmitted to the host where it is further processed. There are several methods which are described in the following. Detailed programming examples are to be found in Annex D.

4.7.4.1 Service request, making use of the hierarchy structure

Under certain circumstances, the device can send a "service request" (SRQ) to the host. As Fig. 4-5 shows, an SRQ is always initiated if one or several bits of bits 0, 1, 2, 3, 4, 5 or 7 of the status byte are set and enabled in the SRE. Each of these bits combines the information of a further register, the error queue or the output buffer. By setting the ENABLE sections of the status registers correspondingly it can be achieved that any bits in any status register initiate an SRQ. In order to make use of the possibilities of the service request, all bits should be set to "1" in enable registers SRE and ESE.

Examples (also see Fig. 4-5):

Use command "`*OPC`" to generate an SRQ

- Set bit 0 in the ESE (Operation Complete)
- Set bit 5 in the SRE

After completion of the settings, the device generates an SRQ.

Indication of a signal during a sweep by means of an SRQ at the host

- Set bit 7 in the SRE (summary bit of the STATus:OPERation register)
- Set bit 3 (SWEeping) in the STATus:OPERation:ENABLE.
- Set bit 3 in the STATus:OPERation:NTRansition so that the change of SWEeping bit 3 from 0 to 1 is also recorded in the EVENT section.
- Set bit 0 in STATus:OPERation:SWEeping:ENABLE
- Set bit 0 in STATus:OPERation:SWEeping:PTRansition so that the change of hold bit 0 from 0 to 1 is also recorded in the EVENT section.

The device generates an SRQ after a signal has been found.

The SRQ is the only possibility for the device to become active on its own. Each host program should set the device so that a service request is initiated in case of malfunction. The program should react appropriately to the service request. A detailed example for a service request routine can be found in Annex D, Programming Examples.

4.7.4.2 Query by means of commands

Each part of every status register can be read by means of queries. The individual commands are indicated in the detailed description of the registers in section "Description of the status registers" on page 131. Only one number is returned which represents the bit pattern of the register queried. The format of the number can be set by the `FORMat:SREGister` command.

Queries are usually used after an SRQ in order to obtain more detailed information on the cause of the SRQ.

4.7.4.3 Error-queue query

Each error state in the device results in an entry in the error queue. The entries of the error queue are detailed plain-text error messages which can be queried via the IEC/IEEE bus using the command `SYSTEM:ERROR?`. Each call of `SYSTEM:ERROR?` provides an entry from the error queue. If no error messages are stored there any more, the device responds with 0, "No error".

The error queue should be queried after every SRQ in the controller program as the entries describe the cause of an error more precisely than the status registers. Especially during the test phase of a controller program the error queue should be queried regularly since faulty commands from the controller to the device are recorded there as well.

4.7.5 Resetting values of the status reporting system

Table 4-12 comprises the different commands and events causing the status reporting system to be reset. None of the commands, except for *RST, influences the functional device settings. In particular, DCL does not change the device settings.

Table 4-12 Resetting device functions

Event	Switching on supply voltage	DCL, SDC			
		(Device Clear, Selected Device Clear)	*RST	STATUS:PRESet	*CLS
Effect					
Clear STB, ESR	yes	—	—	—	yes
Clear SRE, ESE	yes	—	—	—	—
Clear PPE	yes	—	—	—	—
Clear EVENTt sections of the registers	yes	—	—	—	yes
Clear ENABLE section of all OPERATION and QUESTIONable registers, Fill ENABLE sections of all other registers with "1".	yes	—	—	yes	—
Fill PTRansition sections with "1", Clear NTRansition sections	yes	—	—	yes	—
Clear error queue	yes	—	—	—	yes
Clear output buffer	yes	yes	1)	1)	1)
Clear command processing and input buffer	yes	yes	—	—	yes

1) The first command in a line, ie immediately following a <PROGRAM MESSAGE TERMINATOR> clears the output buffer.

5 Maintenance and Troubleshooting

5.1 Maintenance

5.1.1 Alignment of the 10-MHz reference oscillator crystal in the IF section

In order to ensure accurate receiver frequencies the internal 10-MHz-reference oscillator crystal must be trimmed every year.

⇒ Remove the covers.

At the left side there is a sheet metal with square holes in it. In that sheet metal there is an 8-mm hole. Behind that hole there is the trimmer (part of EB200Z1) for the frequency of the reference oscillator.

A 1.5-mm screwdriver for cheese head screws is required.

⇒ Connect a frequency counter with a tolerance $\leq 1 \times 10^{-8}$ to X4 REF EXT/INT at the rear panel.

⇒ Start the internal reference.

⇒ Trim the frequency to 10 MHz \pm 0.5 Hz at room temperature.

5.1.2 Re-establishing the original state, coldstart

A coldstart can be carried out by resetting the unit. All device settings (parameters, memory locations and UDP configuration) will thus be reset to the original state (factory setting). This may become necessary after a firmware update when certain versions are changed. A reset is made on the switched-on unit by briefly connecting connector X8, pin 31 on the rear panel to ground (eg by using a pair of tweezers).

5.1.3 Firmware Update

If a module is exchanged, a firmware update might be required.

In that case a diskette carrying the current firmware will be shipped together with the new module.

On the diskette there are also the "Release Notes" with instructions for the firmware installation.

The "Release Notes" describe also the changes for this specific option.



The firmware can also be downloaded via the following Internet address:

<http://www.rohde-schwarz.com>

5.2 Troubleshooting

5.2.1 Accessories

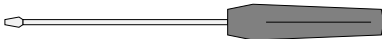
(not included in shipment)

	Crosstip screwdriver #1
	Screwdriver, 1.5 mm
	TORX-screwdriver, size TX6
	1.3 mm Allen key

5.2.2 Error messages

Error message	Cause	Module
Backup LI-Battery low	The lithium backup battery for storing parameters in the CMOS RAM is dead.	LI-battery
DC Converter defective	The DC/DC converter indicates an error.	A11
DSP IF Section defective	The IF section (EB200Z1) indicates an error.	A8
Front Panel defective	The front panel control unit (EB200F1) indicates an error.	A3
Frontend defective	The standard frontend indicates an error.	A7
Frontend1 defective	The standard frontend indicates an error.	A7
Frontend2 defective	The standard frontend indicates an error.	A7
IF Panorama defective	The IF panorama module (EB200SU) indicates an error. The EB200SU is optional.	A9
IF Prefilter narrow defective	The IF section (EB200Z1) indicates an error.	A8
IF Prefilter wide defective	The IF section (EB200Z1) indicates an error.	A8
IF Section defective	The IF section (EB200Z1) indicates an error.	A8
Preselector 20..80 MHz defective	The preselection (EB200V1) indicates an error.	A6
Preselector 80..200 MHz defective	The preselection (EB200V1) indicates an error.	A6
Preselector 200..650 MHz defective	The preselection (EB200V1) indicates an error.	A6
Preselector 650..1500 MHz defective	The preselection (EB200V1) indicates an error.	A6
Preselector 1500..3000 MHz defective	The preselection (EB200V1) indicates an error.	A6
Preselector defective	The preselection (EB200V1) indicates an error.	A6
Remote Interface defective	The remote control interface (eg EB200R2) indicates an error.	A12
Testgenerator defective	The preselection (EB200V1) indicates an error.	A6

5.2.3 List of modules

Module	Description	Order Number
A3	Front Panel Control Unit EB200F1	4052.2600.02
A5	Processor EB200P1	4052.2800.02
A6	Preselection EB200V1	4052.2900.02
A7	Standard Frontend	1093.5491.02
A8	IF Section EB200Z1	4052.3106.02
A9	IF Panorama EB200SU (optional)	4052.3206.02
A11	DC/DC Converter	4052.3358.00
A12	RS232 Interface EB200R2	4052.4002.02
A12	LAN Interface EB200R4 (optional)	4052.9156.02
H1	LCD	4052.5009.00
LI-battery	Lithium battery (type: CR2477) in A5	4052.5673.00
RAM	EXPANSION MODULE	4052.3858.02

5.2.4 Module exchange

5.2.4.1 Opening the unit

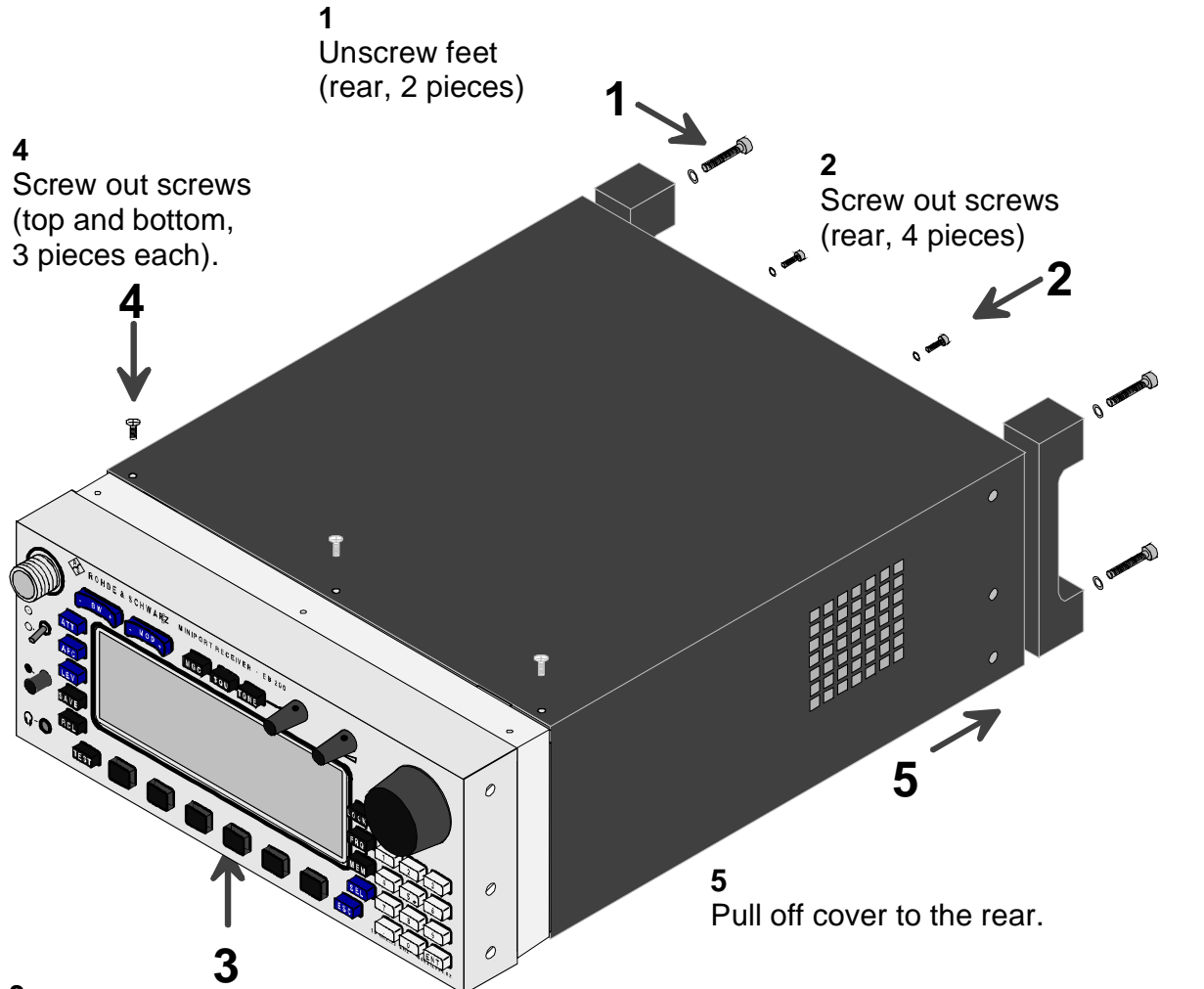

3
Unscrew feet
(bottom, 2 pieces).

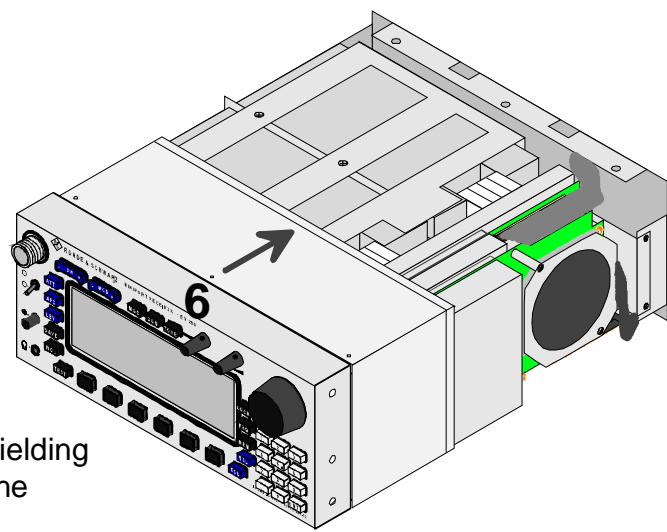

5.2.4.2 DC/DC converter

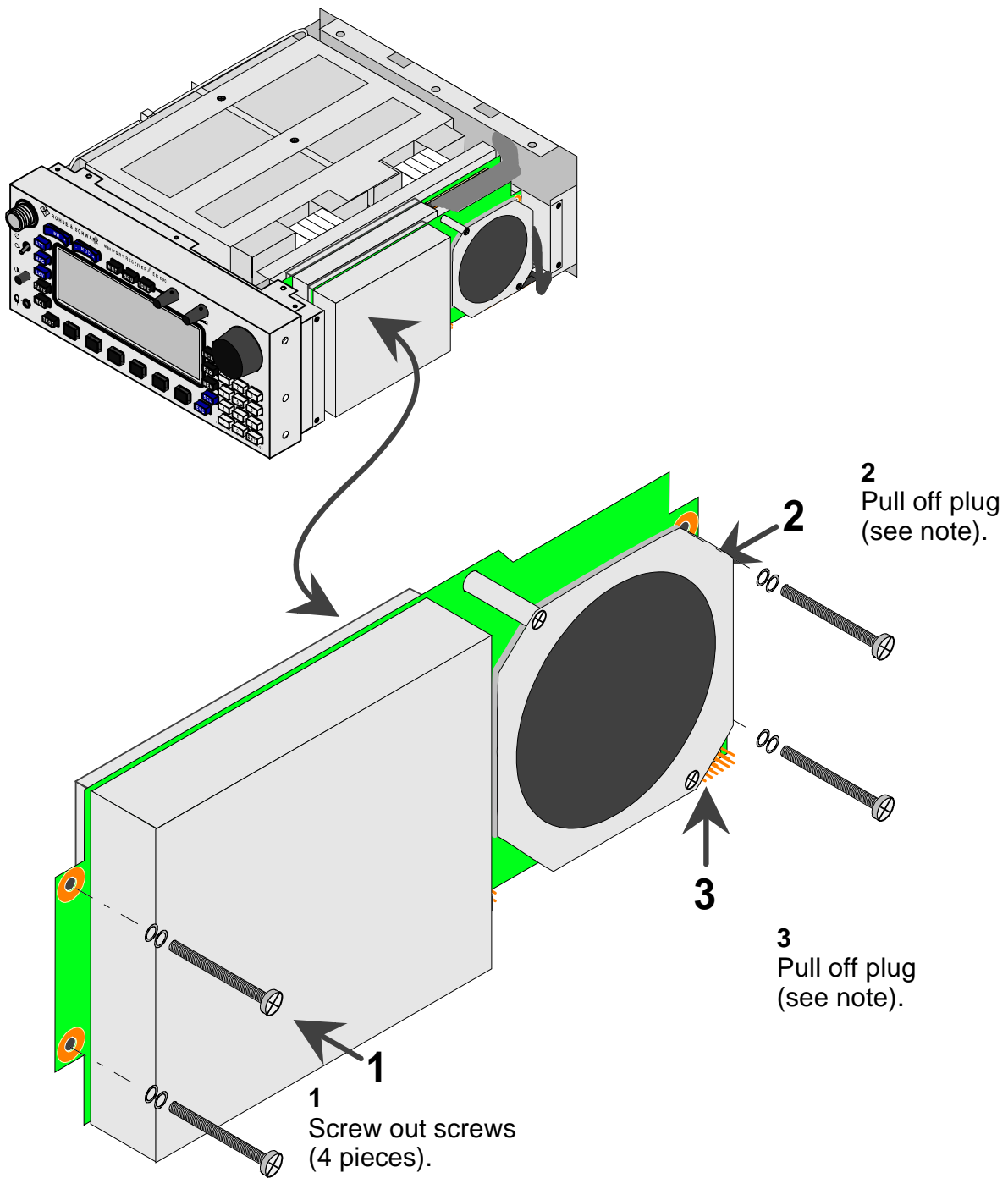

<p>Note: For easy handling pull off the plugs at the motherboard instead.</p>	<p>Attention: All pins must be in the plug and none of them must be bent when the module is installed.</p>
--	---

5.2.4.3 RAM expansion / Li-battery

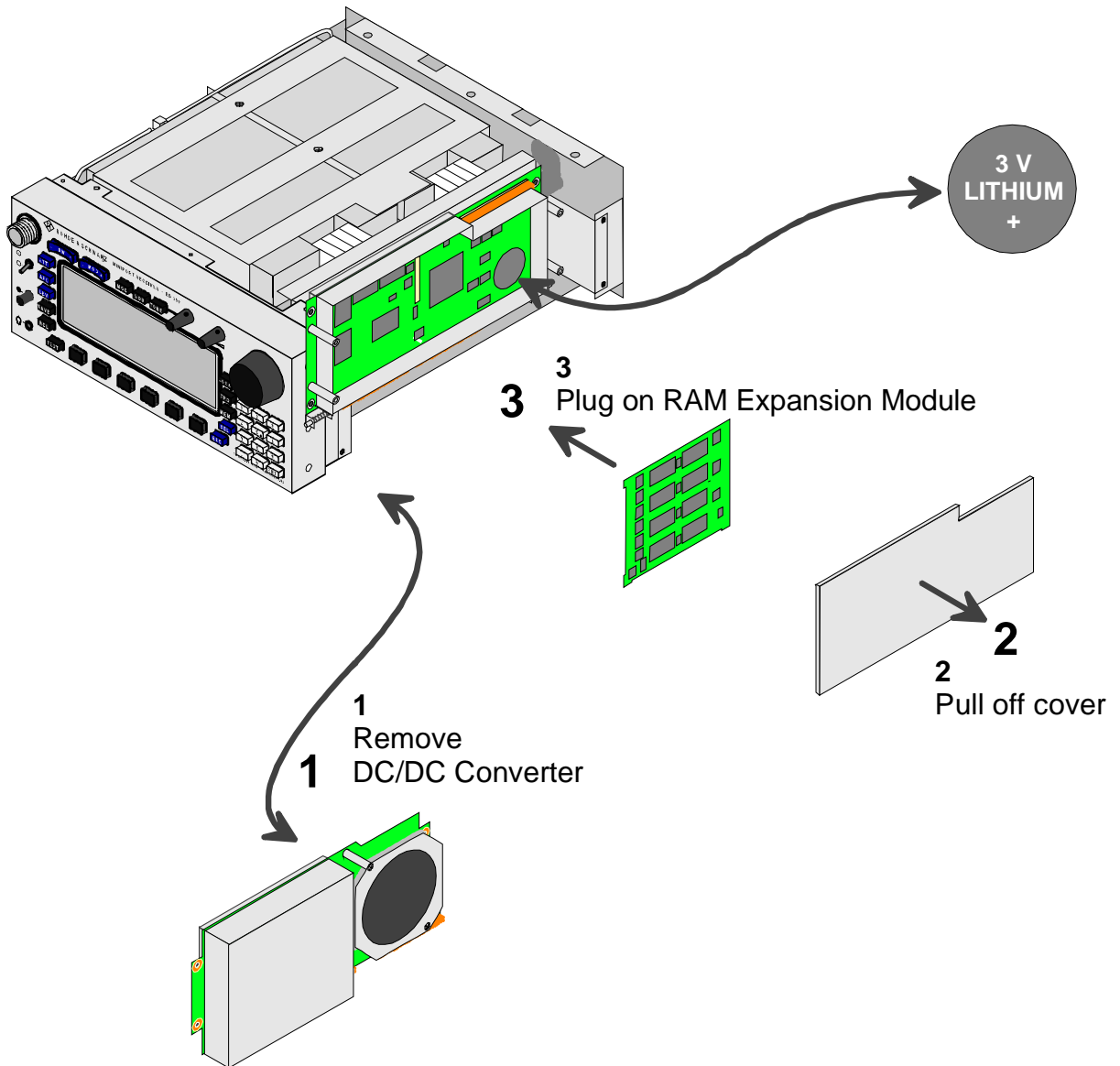

5.2.4.4 Processor module

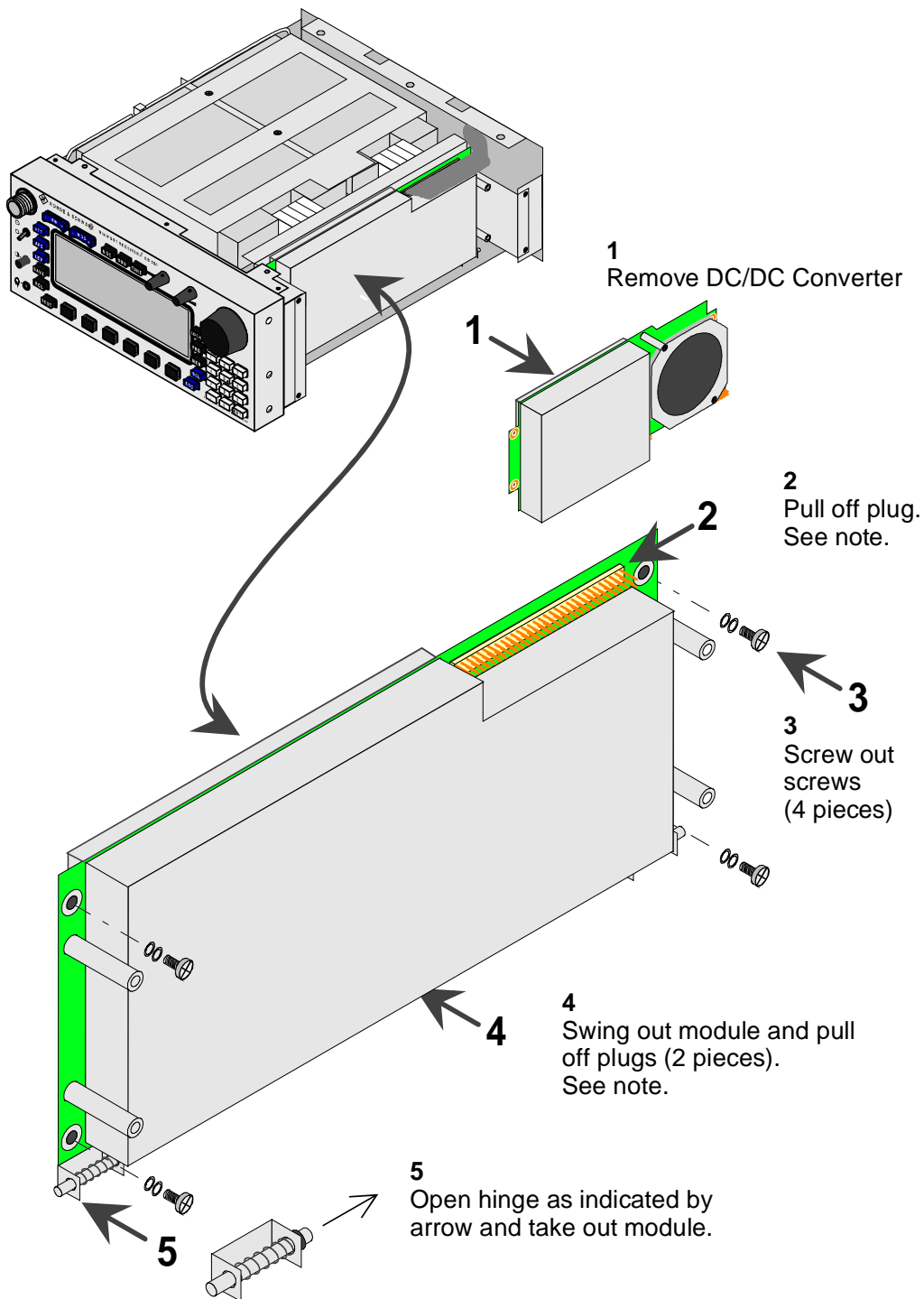

Note:
For easy handling pull off the plugs at the motherboard instead.

Attention:
All pins must be in the plug and none of them must be bent when the module is installed.

5.2.4.5 Front panel control unit and LCD

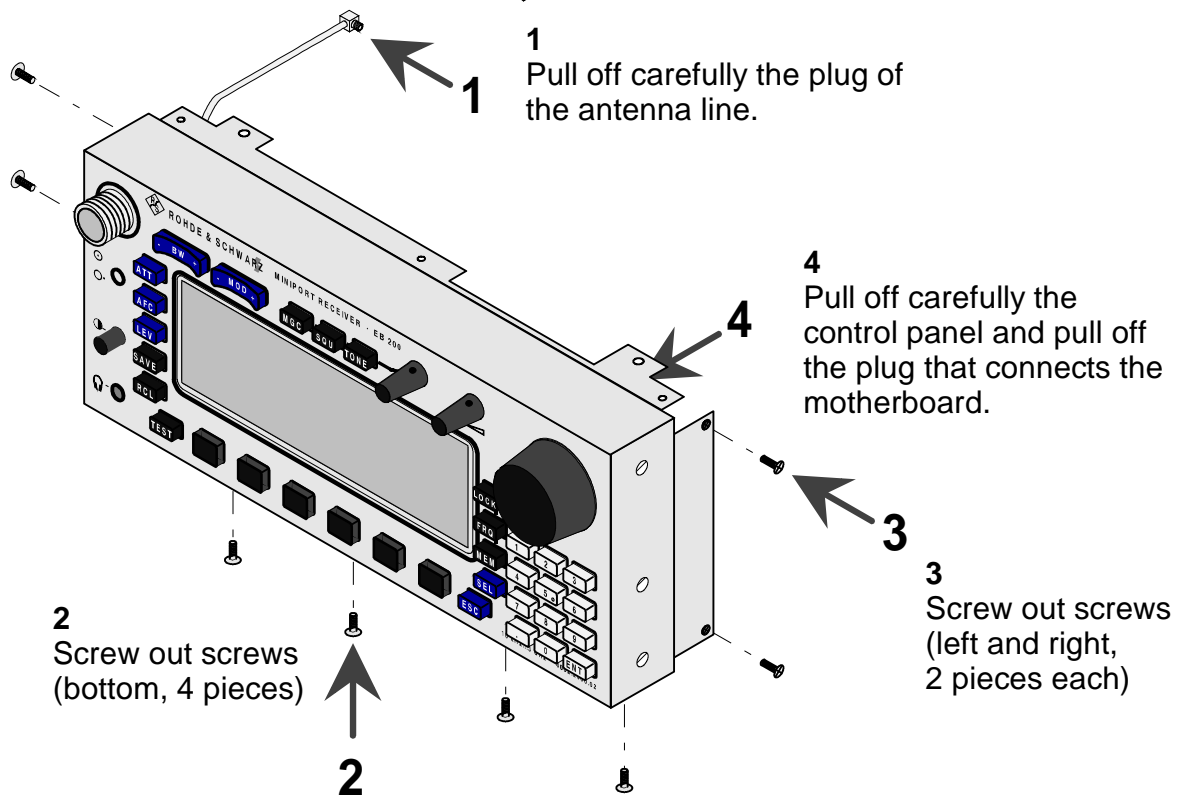
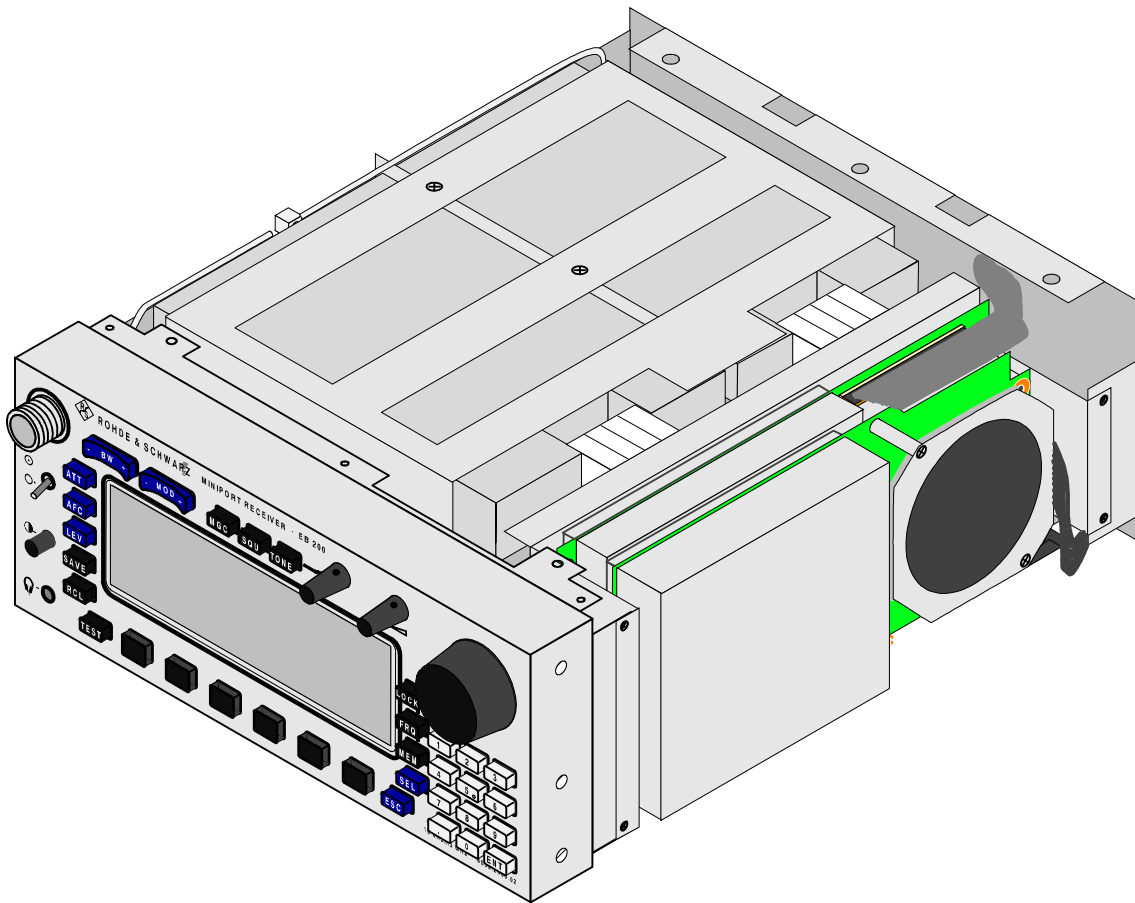

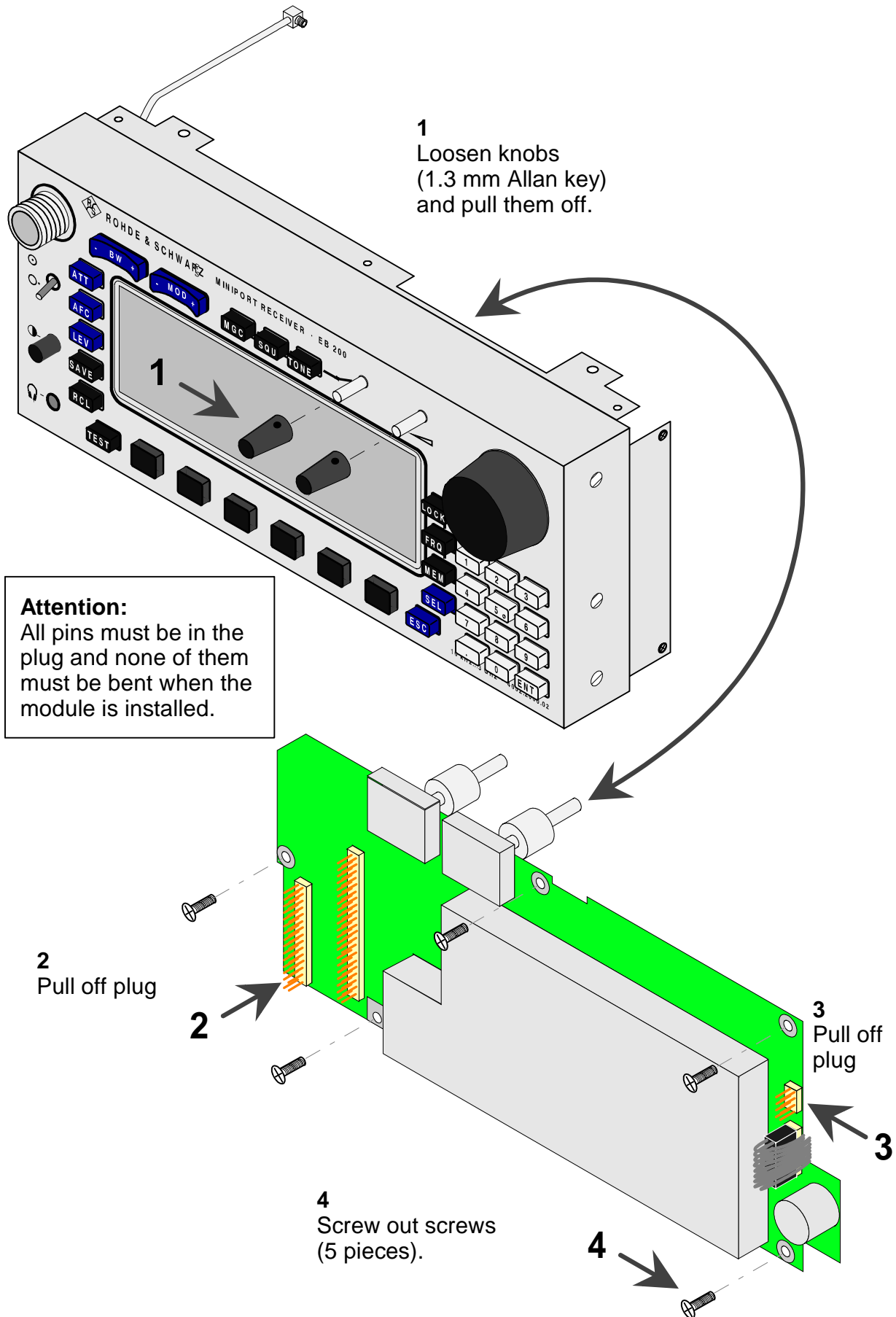

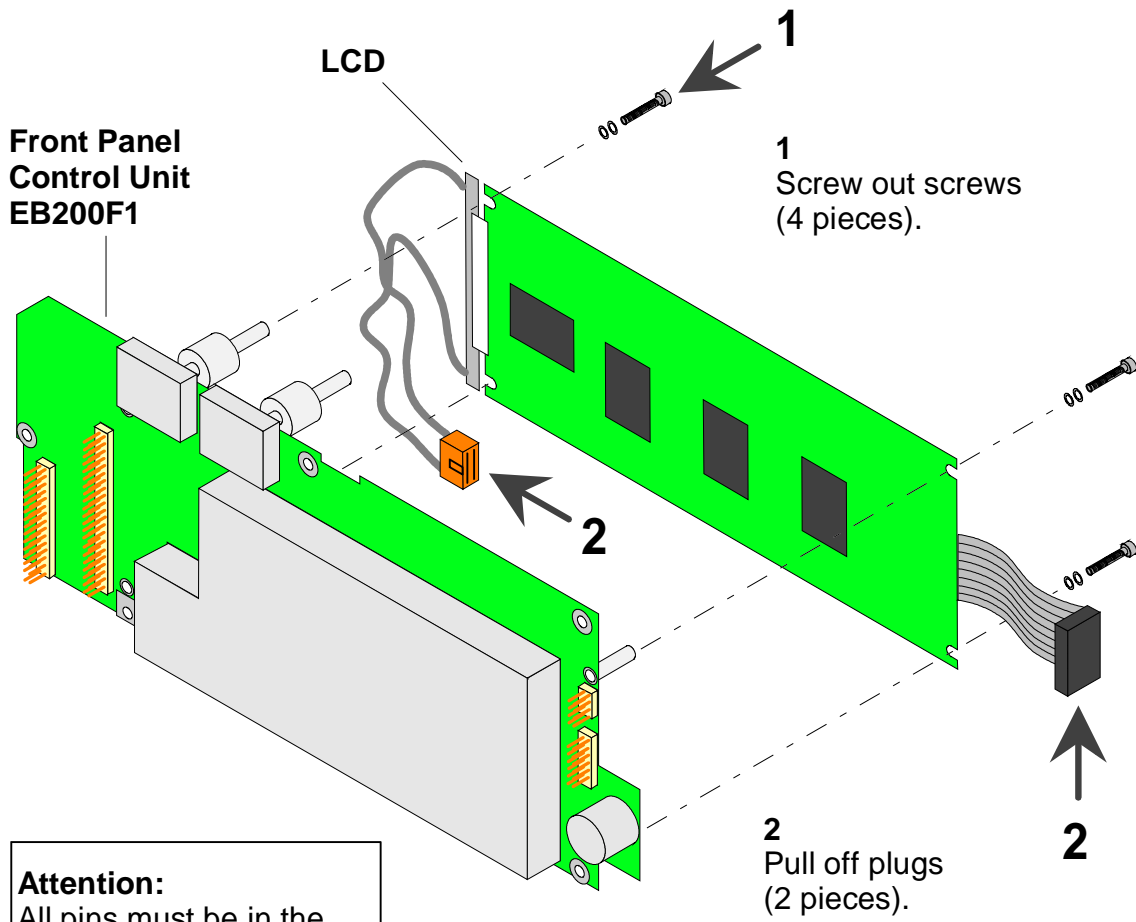

Attention:
All pins must be in the plug and none of them must be bent when the module is installed.

5.2.4.6 Preselection, frontend, IF section, IF-panorama (option)

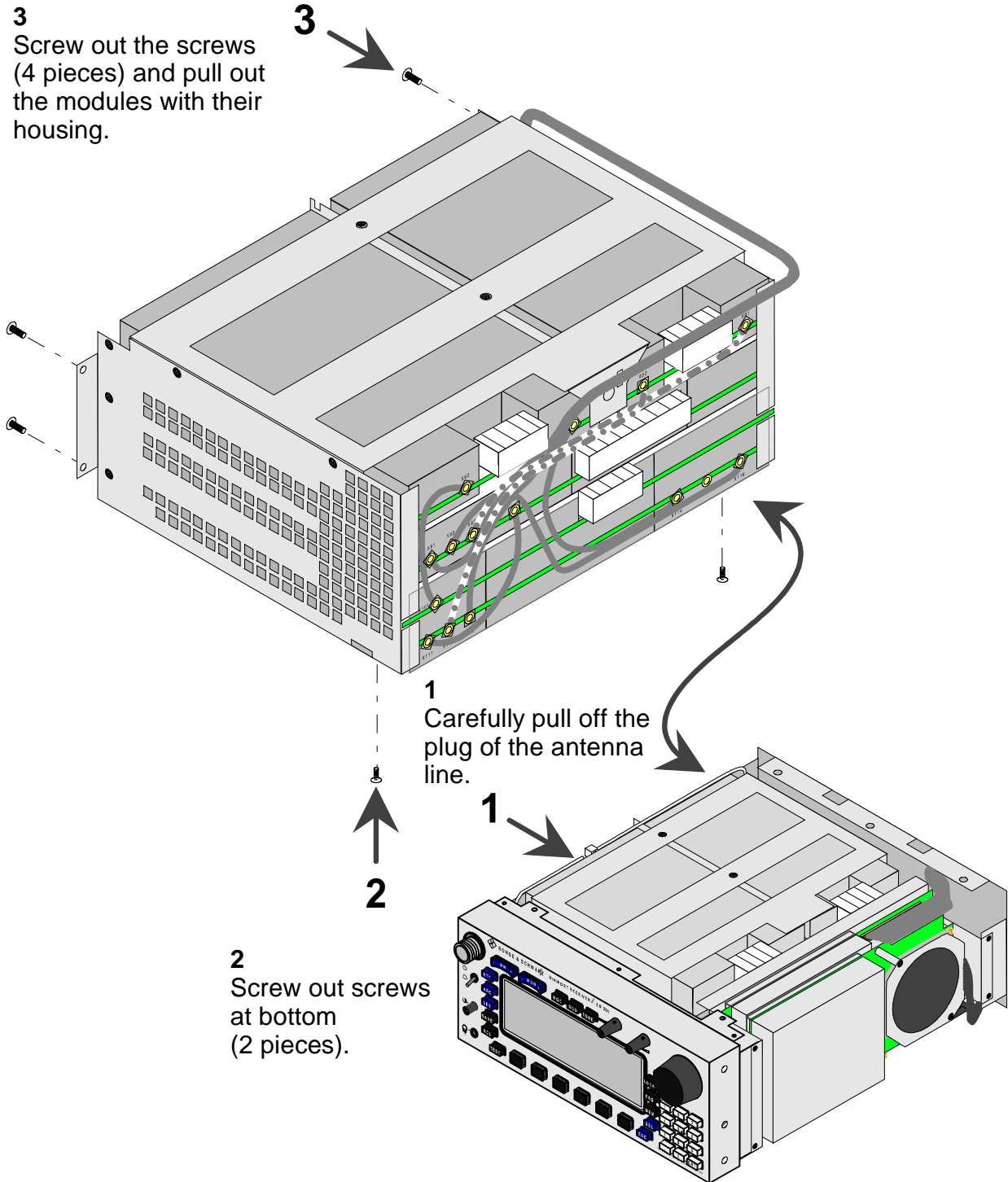

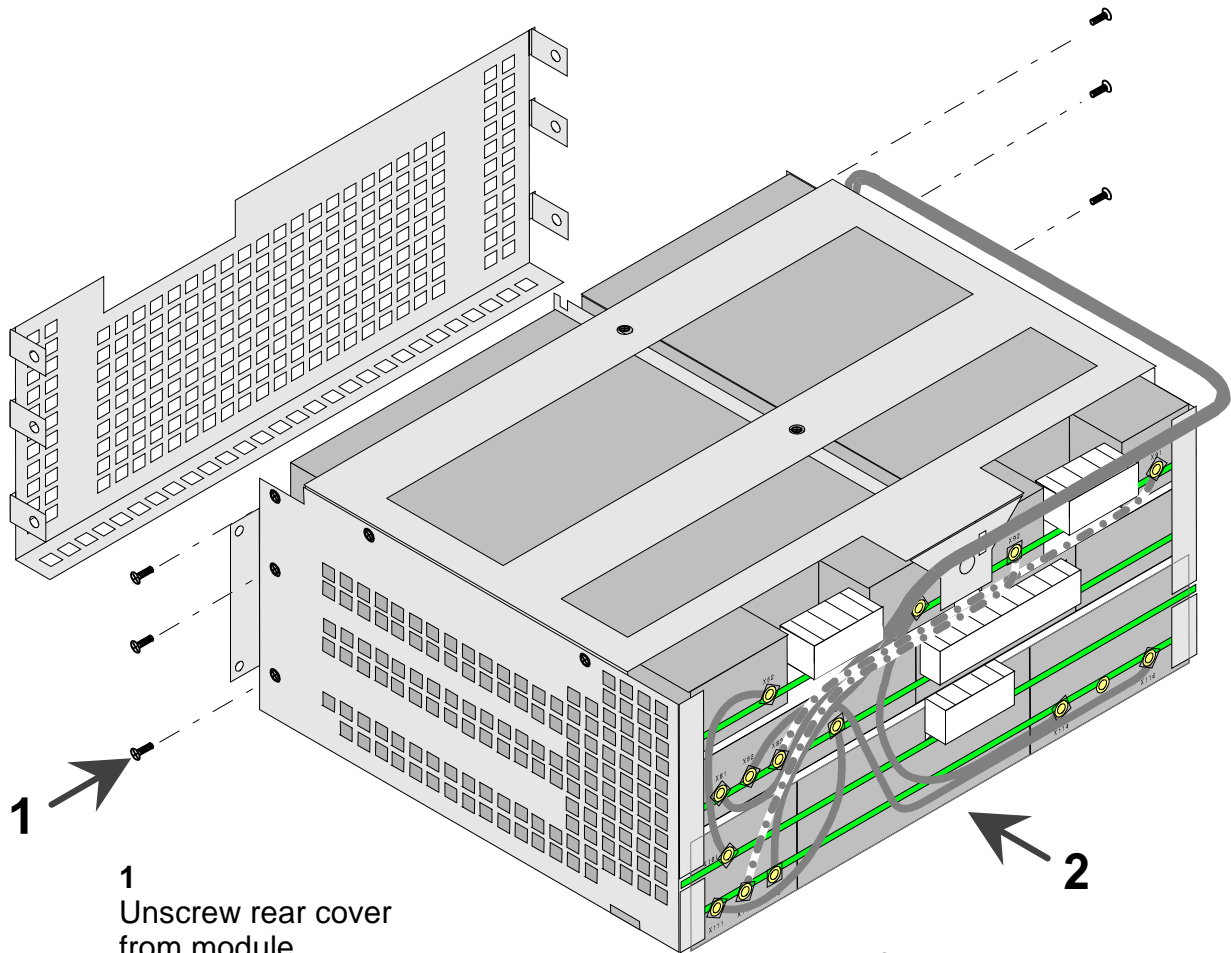

1 →
1 Unscrew rear cover from module housing. (3 screws at each side).

← **2**
2 Pull off plug of module to be exchanged and push out module (see cable plan).

5.2.4.7 Cable plan

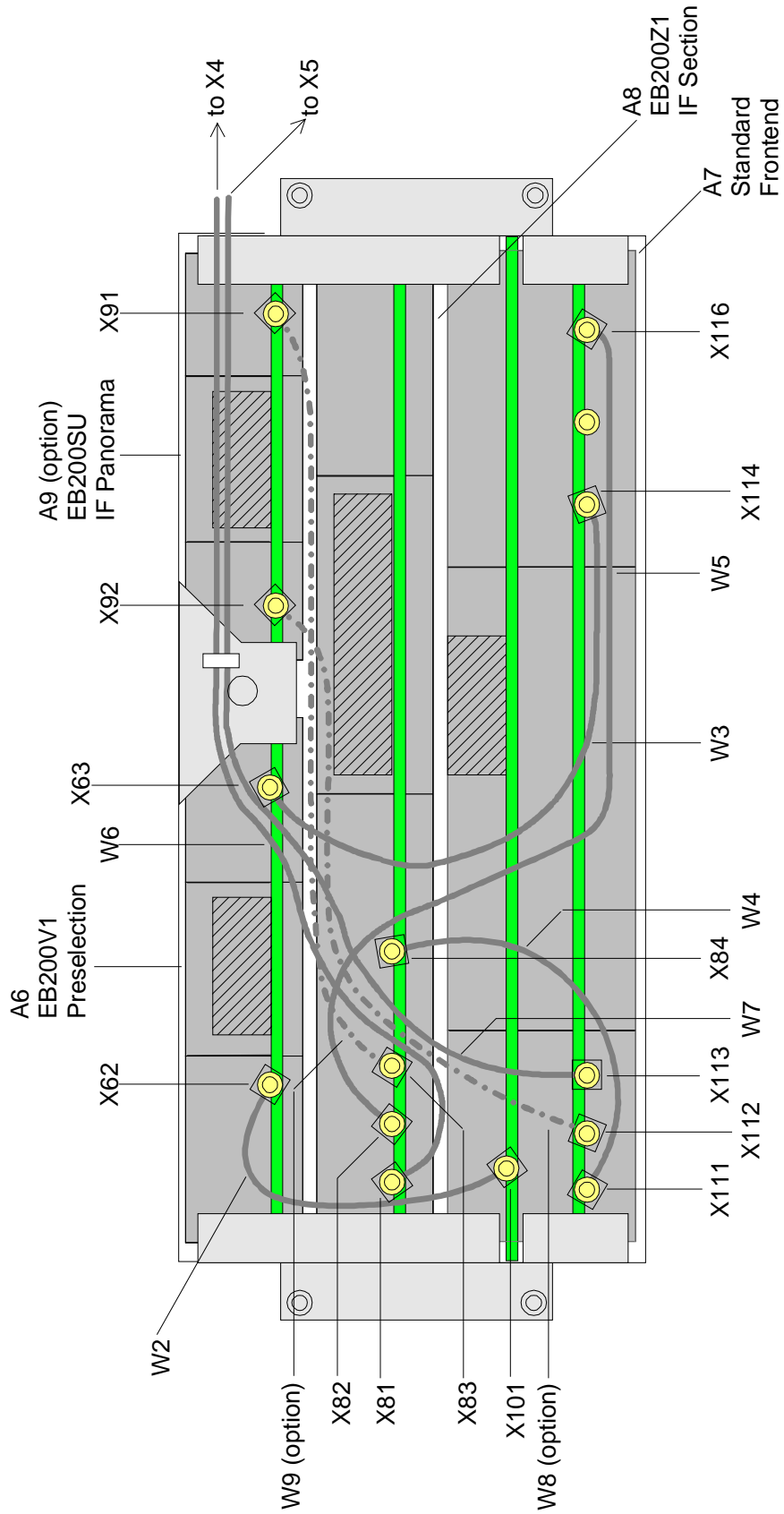

5.2.4.8 RS232 interface

3
Pull off the plug.
Attention:
All pins must be in the plug and none of them must be bent when the module is installed.

1
Screw out the screws
(4 pieces)
and take out the module.

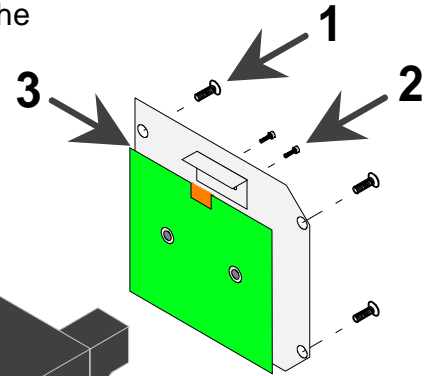

2
Screw out the screws
(2 pieces)
and take off the angle.



5.2.5 Maintenance support

For a complete maintenance service put the unit back into the original packing material and send it to the following service address.

Rohde & Schwarz GmbH & Co. KG

Zentralservice

Mühldorfstr. 15

D-81671 München

Phone: (89) 4129 12263

Fax: (89) 4129 13275